

N-Channel Enhancement Mode MOSFET

1. Product Information

1.1 Features

- Surface-mounted package
- Low Thermal Resistance

1.2 Applications

- Motor drivers
- DC - DC Converter

1.3 Quick reference

- $BV \leq 100\text{ V}$
- $R_{DS(ON)} \leq 75\text{ m}\Omega @ V_{GS} = 10\text{ V}$
- $P_{tot} \leq 20.8\text{ W}$
- $R_{DS(ON)} \leq 85\text{ m}\Omega @ V_{GS} = 4.5\text{ V}$
- $I_D \leq 15\text{ A}$

2. Pin Description

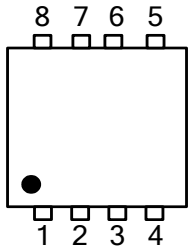
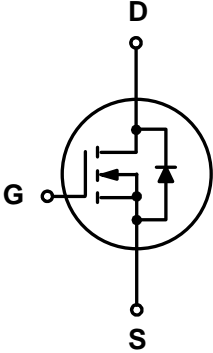
Pin	Description	Simplified Outline	Symbol
1,2,3	Source	 <p style="text-align: center;">Top View PDFN3.3x3.3-8L</p>	
4	Gate		
5,6,7,8	Drain		

3. Limiting Values

Symbol	Parameter	Conditions	Min	Max	Unit
V _{DS}	Drain-Source Voltage	T _C = 25 °C	100	-	V
V _{GS}	Gate-Source Voltage	T _C = 25 °C	-	± 20	V
I _D *	Drain Current (DC)	T _C = 25 °C, V _{GS} = 10 V	-	15	A
		T _C = 100 °C, V _{GS} = 10 V		7.2	A
I _{DM} **	Drain Current (Pulsed)	T _C = 25 °C, V _{GS} = 10 V	-	44	A
P _{tot} *	Total Power Dissipation	T _C = 25 °C	-	20.8	W
T _{stg}	Storage Temperature		- 55	150	°C
T _J	Junction Temperature		-	150	°C
I _S	Diode Forward Current	T _C = 25 °C	-	15	A
E _{AS} *	Single Pulsed Avalanche Energy	V _{DD} = 50 V , L= 1 mH	-	40.5	mJ
R _{θJA} *	Thermal Resistance- Junction to Ambient		-	62.5	°C / W
R _{θJC} *	Thermal Resistance- Junction to Case		-	6	

Notes :

- * Surface Mounted on 1 in² pad area, t ≤ 10 sec
- ** Pulse width ≤ 10 μs, duty cycle ≤ 1 %
- *** Limited by bonding wire

4. Marking Information

Product Name	Marking
KJ15N10Q	<div style="display: inline-block; background-color: black; color: white; padding: 2px;">15N10 YWWXXX</div> YWW: Date Code

5. Ordering Code

Product Name	Package	Reel Size	Tape width	Quantity	Note
KJ15N10Q	PDFN3.3*3.3			5000	

Note: KUAJIEXIN defines " Green " as lead-free (RoHS compliant) and halogen free (Br or Cl does not exceed 900 ppm by weight in homogeneous material and total of Br and Cl does not exceed 1500 ppm by weight; Follow IEC 61249-2-21 and IPC / JEDEC J-STD-020C)



快捷冠

KJ15N10Q

6. Electrical Characteristics (T_A = 25 °C Unless Otherwise Noted)

Symbol	Parameter	Conditions	Min	Typ	Max	Unit
Static Characteristics						
BV _{DSS}	Drain-Source Breakdown Voltage	V _{GS} = 0 V, I _D = 250 μA	100	-	-	V
V _{GS(th)}	Gate Threshold Voltage	V _{DS} = V _{GS} , I _{DS} = 250 μA	1	-	2	V
I _{DSS}	Zero Gate Voltage Source Current	V _{DS} = 80 V, V _{GS} = 0 V	-	-	1	μA
I _{GSS}	Gate Leakage Current	V _{GS} = ± 20 V, V _{DS} = 0 V	-	-	± 100	nA
R _{DS(ON)} ^a	Drain-Source On-State Resistance	V _{GS} = 10 V, I _D = 10 A	-	67	75	mΩ
		V _{GS} = 4.5 V, I _D = 5 A	-	73	85	
Diode Characteristics						
V _{SD} ^a	Diode Forward Voltage	I _{SD} = 10 A, V _{GS} = 0 V	-	-	1.3	V
t _{rr}	Reverse Recovery Time	I _{SD} = 10 A, dI _{SD} /dt = 100 A/μs	-	21	-	nS
Q _{rr}	Reverse Recovery Charge		-	24	-	nC
Dynamic Characteristics^b						
C _{iss}	Input Capacitance	V _{GS} = 0 V, V _{DS} = 50 V Frequency = 1 MHz	-	1662	-	pF
C _{oss}	Output Capacitance		-	34	-	
C _{rss}	Reverse Transfer Capacitance		-	34	-	
t _{d(on)}	Turn-on Delay Time	V _{DS} = 50 V, V _{GEN} = 10 V, R _G = 4.5 Ω, R _L = 5 Ω, I _D = 10 A	-	6.1	-	nS
t _r	Turn-on Rise Time		-	9.5	-	
t _{d(off)}	Turn-off Delay Time		-	31	-	
t _f	Turn-off Fall Time		-	14	-	
Gate Charge Characteristics^b						
Q _g	Total Gate Charge	V _{GS} = 10 V, V _{DS} = 50 V, I _{DS} = 10 A	-	28	-	nC
Q _{gs}	Gate-Source Charge		-	6.9	-	
Q _{gd}	Gate-Drain Charge		-	3.6	-	

Notes :

a : Pulse test ; pulse width ≤ 300 μs, duty cycle ≤ 2 %

b : Guaranteed by design, not subject to production testing



7. Typical Characteristics (Cont.)

Power Capability

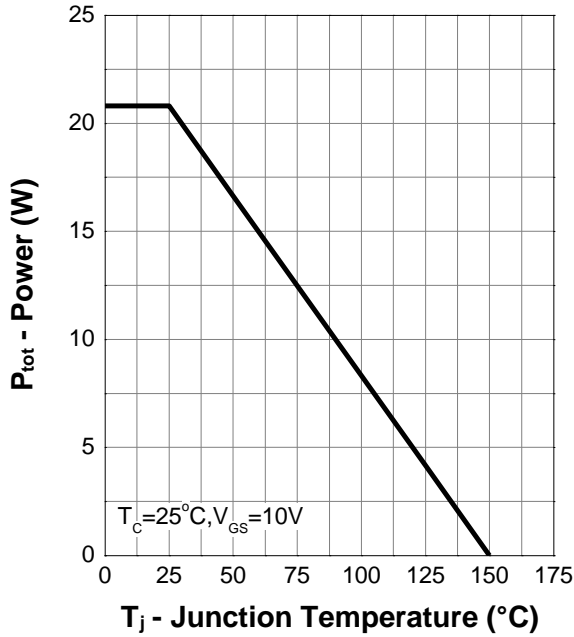

Current Capability

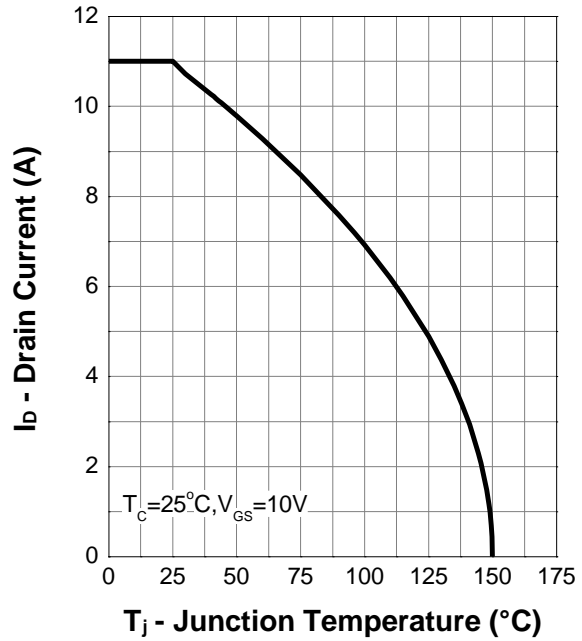

Safe Operation

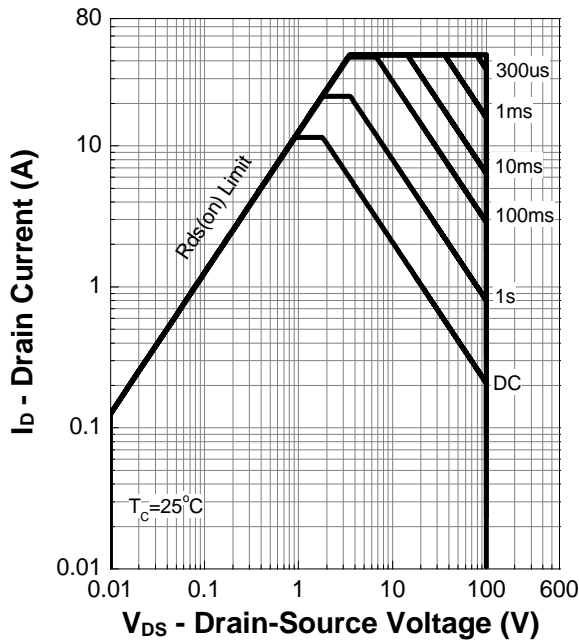

Transient Thermal Impedance

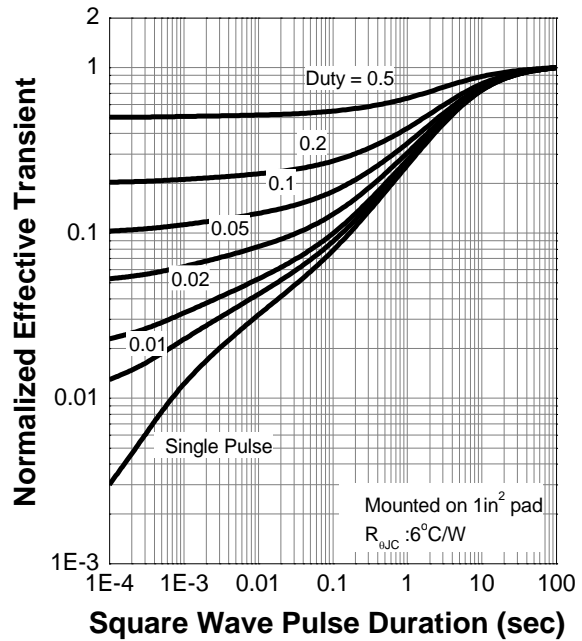



7. Typical Characteristics (Cont.)

Output Characteristics

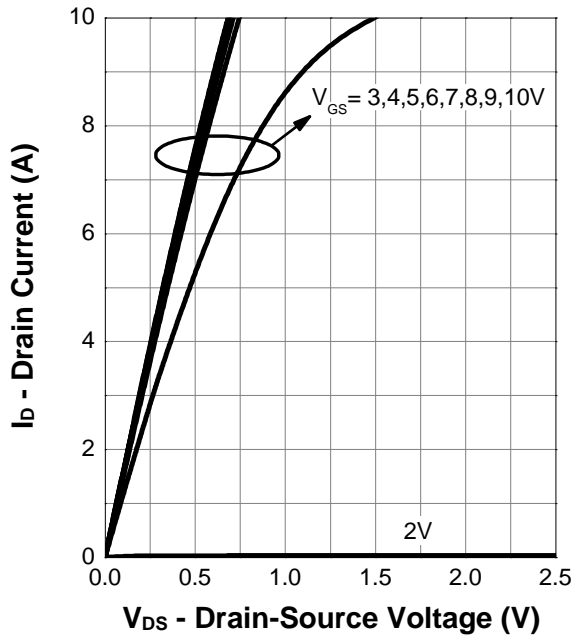

On Resistance

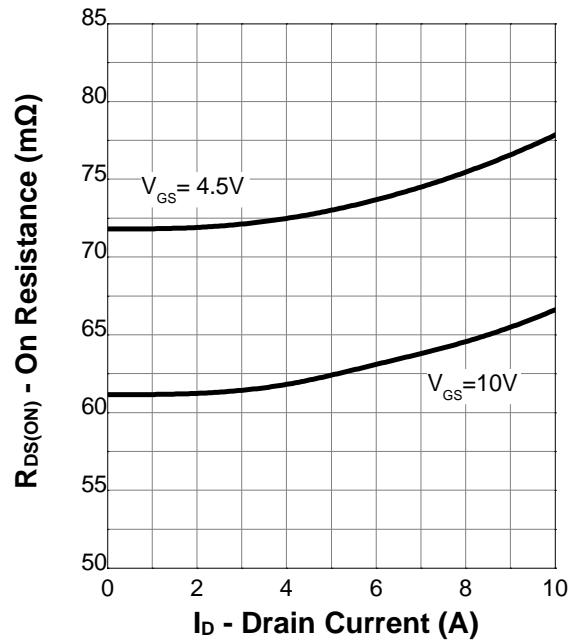

Transfer Characteristics

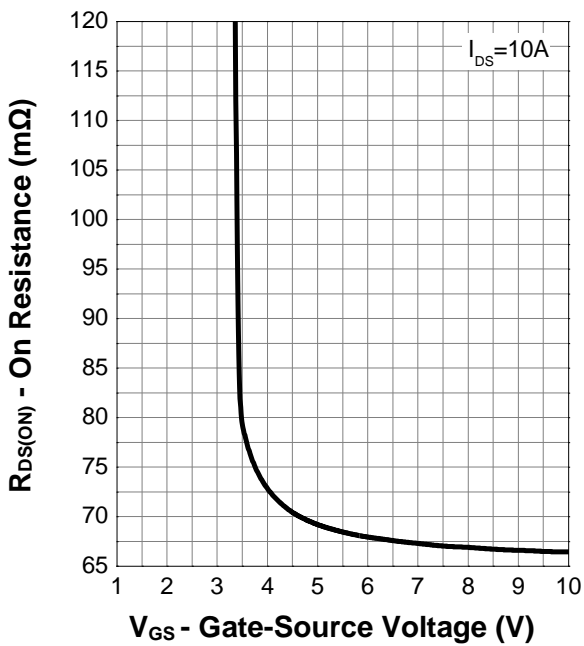

Normalized Threshold Voltage

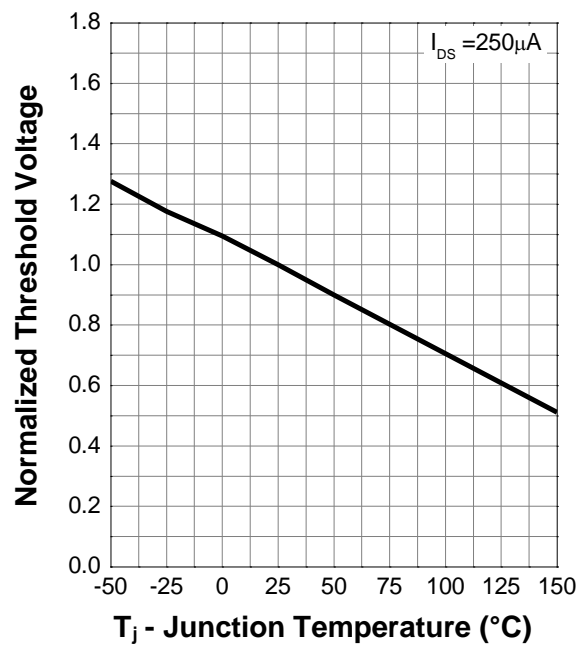



7. Typical Characteristics (Cont.)

Normalized On Resistance

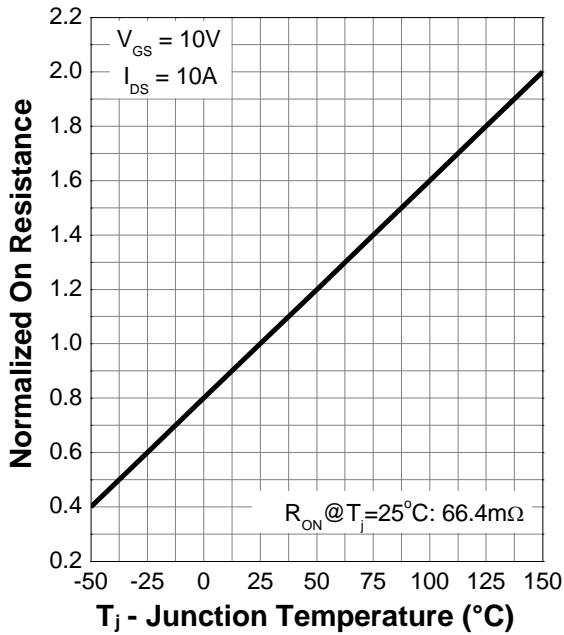

Diode Forward Current

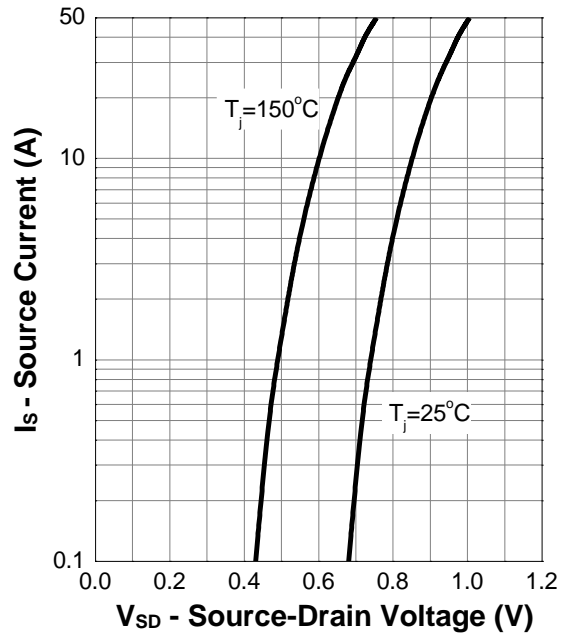

Capacitance

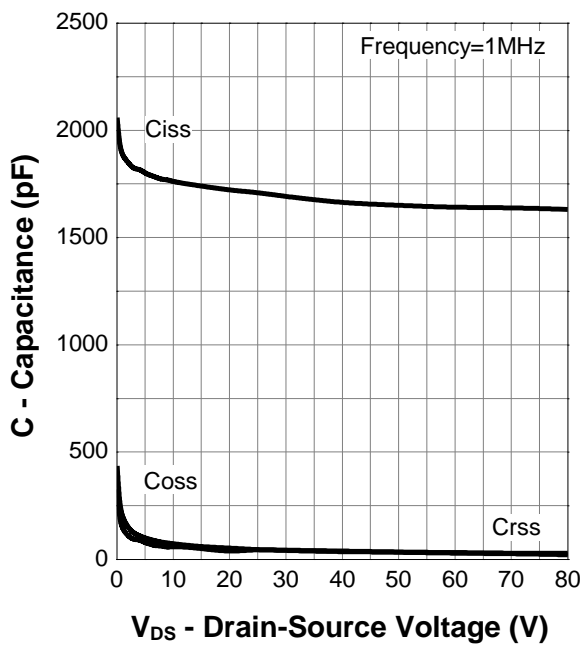

Gate Charge

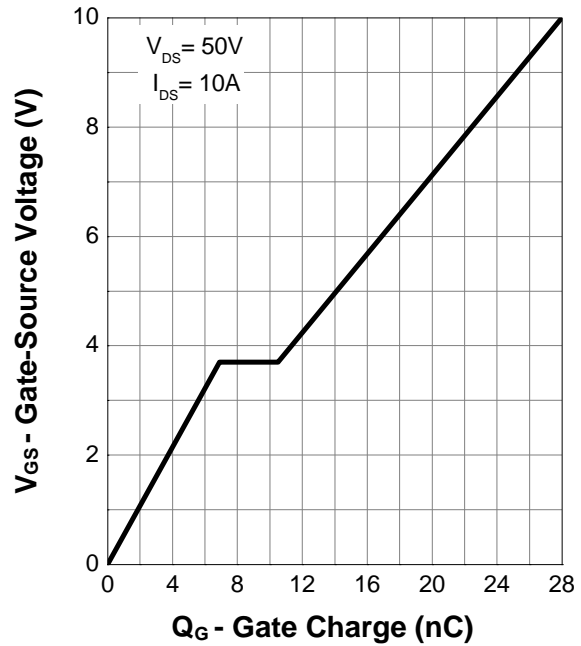



快捷冠

KJ15N10Q

8. Package Dimensions

DFN 3x3-8L Package

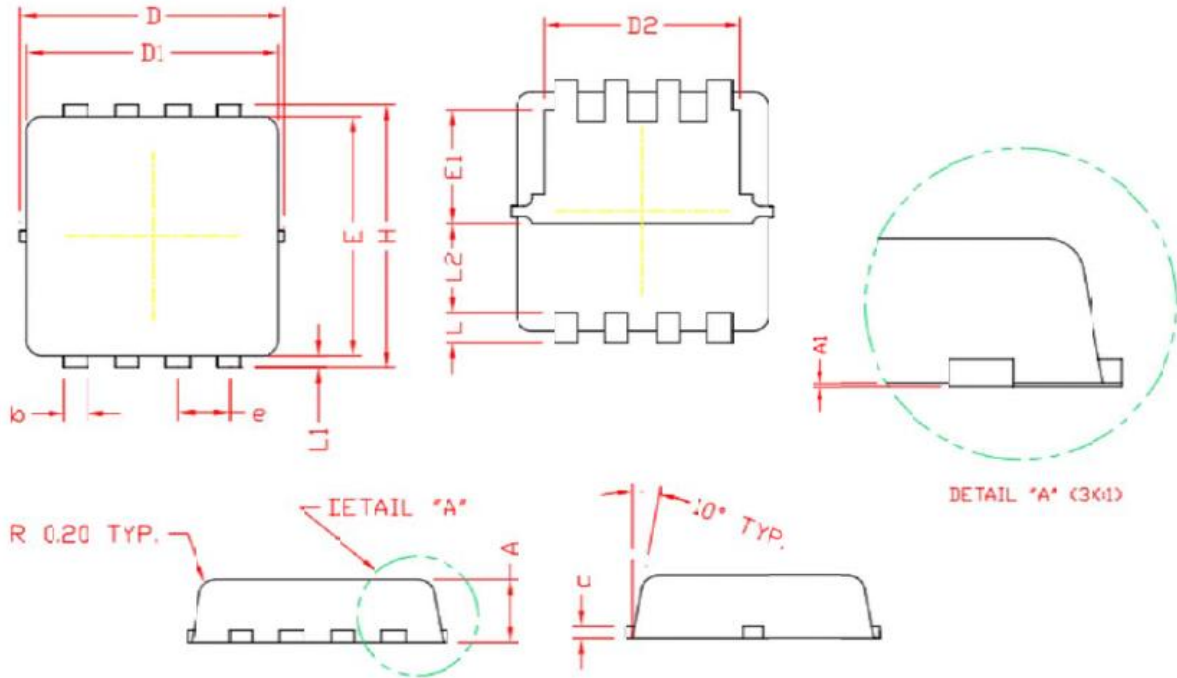

Symbol	Dimensions In Millimeters	
	MIN.	MAX.
A	0.70	0.90
A1	0.00	0.05
b	0.24	0.35
c	0.10	0.20
D	3.25	3.40
D1	3.05	3.25
D2	2.40	2.60
E	3.00	3.20
E1	1.35	1.55
e	0.65 BSC.	
H	3.20	3.40
L	0.30	0.50
L1	0.10	0.20
L2	1.13 REF.	