

P-Channel Enhancement Mode MOSFET

1. Product Information

1.1 Features

- Surface-mounted package
- Advanced trench cell design

1.2 Applications

- LCD TV appliances
- High power inverter system
- LCDM appliances

1.3 Quick reference

- $BV \geq -60\text{ V}$
- $R_{DS(ON)} \leq 6.0\text{ m}\Omega @ V_{GS} = -10\text{ V}$
- $P_{tot} \leq 156\text{ W}$
- $R_{DS(ON)} \leq 7.7\text{ m}\Omega @ V_{GS} = -4.5\text{ V}$
- $I_D \leq -120\text{ A}$

2. Pin Description

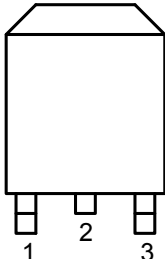
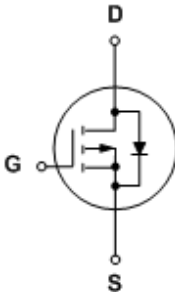
Pin	Description	Simplified Outline	Symbol
1	Gate(G)	 <p>Top View TO263-2L</p>	
2	Drain(D)		
3	Source(S)		

3. Limiting Values

Symbol	Parameter	Conditions	Min	Max	Unit
V_{DS}	Drain-Source Voltage	$T_C = 25\text{ }^\circ\text{C}$	- 60	-	V
V_{GS}	Gate-Source Voltage	$T_C = 25\text{ }^\circ\text{C}$	-	± 20	V
I_D^{****}	Drain Current (DC)	$T_C = 25\text{ }^\circ\text{C}, V_{GS} = - 10\text{ V}$	-	- 120	A
I_D^*		$T_C = 100\text{ }^\circ\text{C}, V_{GS} = - 10\text{ V}$	-	- 79	A
I_{DM}^{*****}	Drain Current (Pulsed)	$T_C = 25\text{ }^\circ\text{C}, V_{GS} = - 10\text{ V}$	-	- 180	A
P_{tot}^*	Drain power dissipation	$T_C = 25\text{ }^\circ\text{C}$	-	156	W
T_{stg}	Storage Temperature		-55	150	$^\circ\text{C}$
T_J	Junction Temperature		-	150	$^\circ\text{C}$
I_S	Continuous-Source Current	$T_C = 25\text{ }^\circ\text{C}$	-	- 120	A
E_{AS}^*	Single Pulsed Avalanche Energy	$V_{DD} = - 50\text{ V}, L = 1\text{ mH}$	-	648	mJ
$R_{\theta JA}^*$	Thermal Resistance- Junction to Ambient		-	62.5	$^\circ\text{C/W}$
$R_{\theta JC}^*$	Thermal Resistance- Junction to Case		-	0.8	

Notes :

* Surface Mounted on 1 in² pad area, $t \leq 10\text{ sec}$

** Pulse width $\leq 300\text{ }\mu\text{s}$, duty cycle $\leq 2\%$

*** Limited by bonding wire

4. Marking Information

Product Name	Marking
KJ120P06D	<div style="display: inline-block; border: 1px solid black; padding: 2px;"> 120P06 YWWXXX </div> YWWXXX: Date Code

5. Ordering Code

Product Name	Package	Reel Size	Tape width	Quantity	Note
KJ120P06D	TO263			800	

Note: KUAJIEXIN defines " Green " as lead-free (RoHS compliant) and halogen free (Br or Cl does not exceed 900 ppm by weight in homogeneous material and total of Br and Cl does not exceed 1500 ppm by weight; Follow IEC 61249-2-21 and IPC / JEDEC J-STD-020C)

6. Electrical Characteristics (TA=25 ° Unless Otherwise Noted)

Symbol	Parameter	Conditions	Min	Typ	Max	Unit
Static Characteristics						
BV _{DSS}	Drain-Source Breakdown Voltage	V _{GS} = 0 V, I _{DS} = - 250 μA	-60	-	-	V
V _{GS(th)}	Gate Threshold Voltage	V _{DS} = V _{GS} , I _{DS} = - 250 μA	- 1	-	- 2	V
I _{DSS}	Drain Leakage Current	V _{DS} = - 48 V, V _{GS} = 0 V	-	-	- 1	μA
I _{GSS}	Gate Leakage Current	V _{GS} = 0 V, V _{GS} = ± 20 V	-	-	±100	nA
R _{DS(ON)} ^a	On-State Resistance	V _{GS} = - 10 V, I _{DS} = - 50 A	-	5.5	6.0	mΩ
		V _{GS} = - 4.5 V, I _{DS} = - 30 A	-	6.8	7.7	
Diode Characteristics						
V _{SD} ^a	Diode Forward Voltage	I _{SD} = - 50 A, V _{GS} = 0 V	-	-	- 1.3	V
t _{rr}	Reverse Recovery Time	I _{DS} = - 50 A, dI _{SD} /dt = 100 A/μs	-	24	-	nS
Q _{rr}	Reverse Recovery Charge		-	12	-	nC
Dynamic Characteristics^b						
C _{iss}	Input Capacitance	V _{GS} = 0 V, V _{DS} = - 30 V Frequency = 1 MHz	-	11842	-	pF
C _{oss}	Output Capacitance		-	646	-	
C _{riss}	Reverse Transfer Capacitance		-	193	-	
t _{d(on)}	Turn-on Delay Time	V _{DS} = - 30 V, V _{GEN} = - 10 V, R _G = 3.9 Ω, R _L = 0.6 Ω, I _{DS} = - 50 A	-	24	-	nS
t _r	Turn-on Rise Time		-	146	-	
t _{d(off)}	Turn-off Delay Time		-	254	-	
t _f	Turn-off Fall Time		-	172	-	
Gate Charge Characteristics^b						
Q _g	Total Gate Charge	V _{DS} = - 30 V, V _{GS} = - 10 V, I _{DS} = - 50 A	-	207	-	nC
Q _{gs}	Gate-Source Charge		-	48	-	
Q _{gd}	Gate-Drain Charge		-	33	-	

Notes :

a : Pulse test ; pulse width ≤ 300 μs, duty cycle ≤ 2%

b : Guaranteed by design, not subject to production testing

7. Typical Characteristics

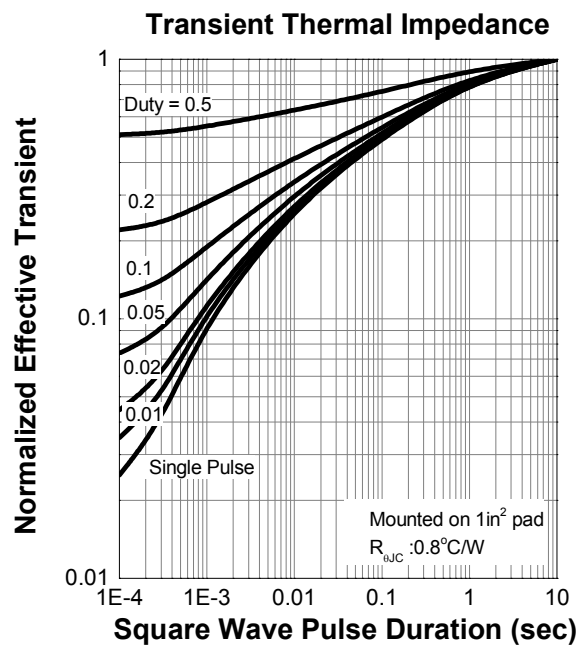
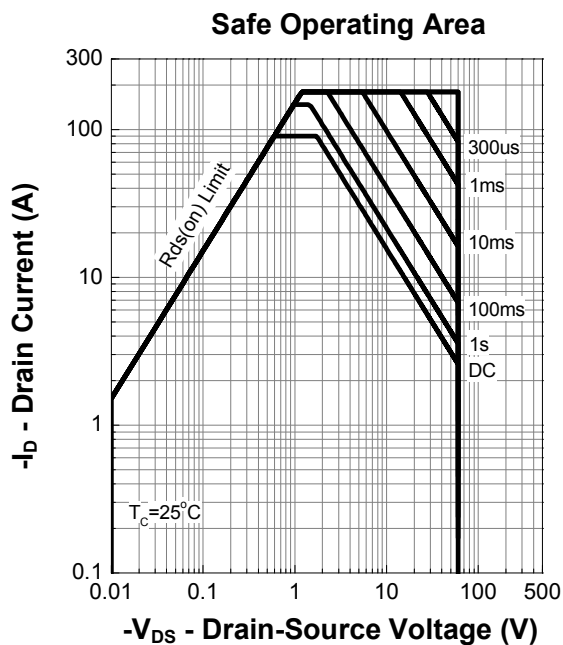
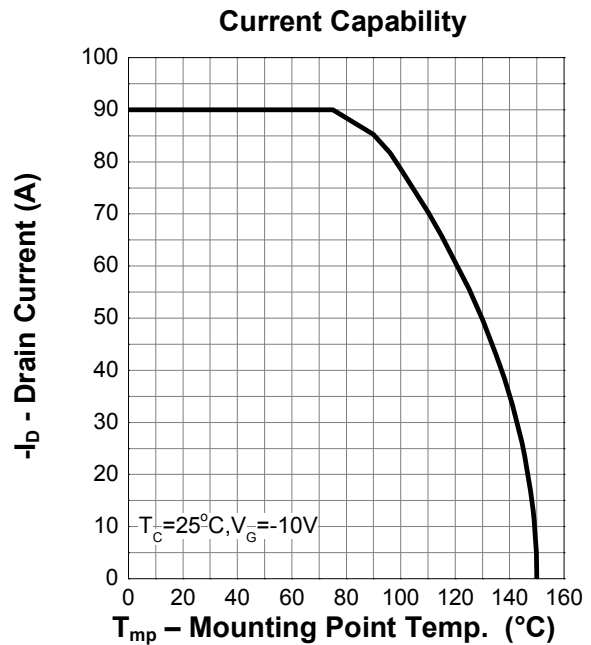
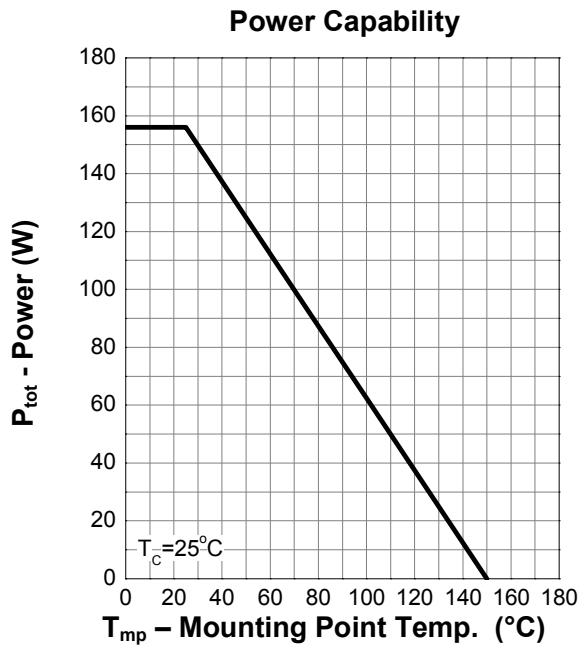

7. Typical Characteristics (cont.)

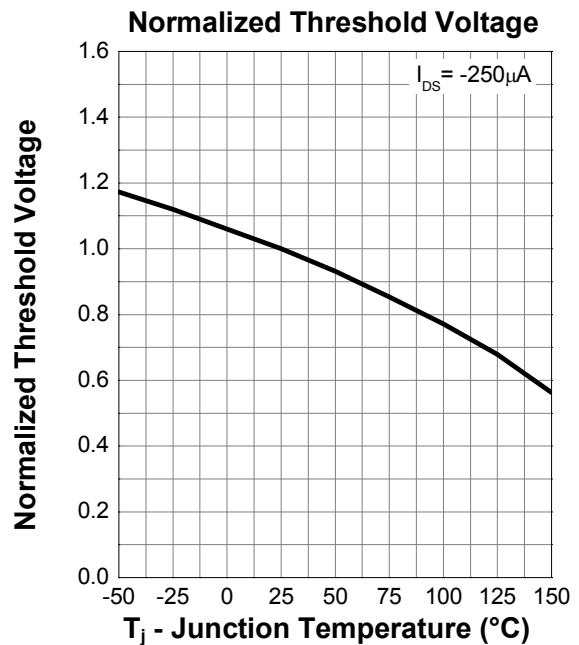
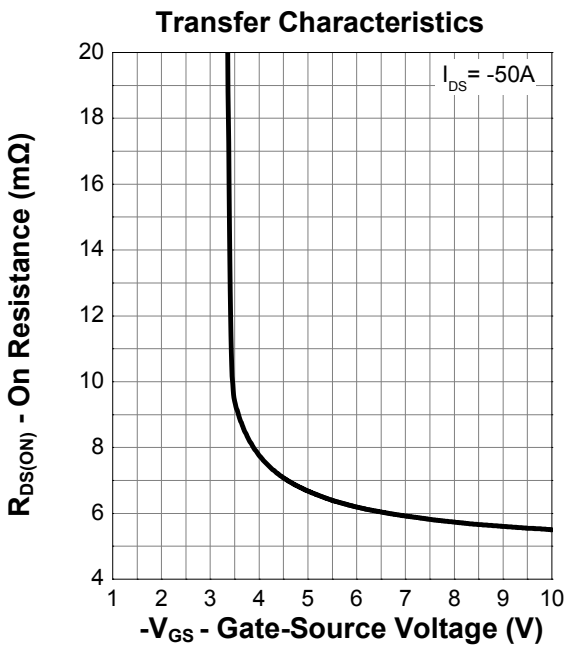
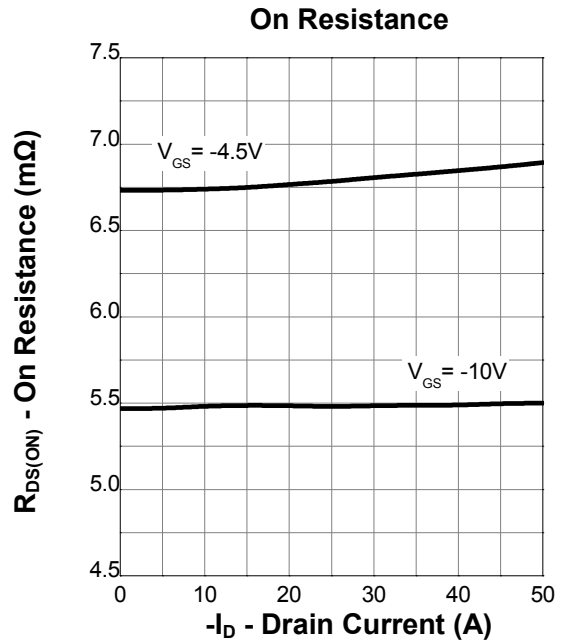
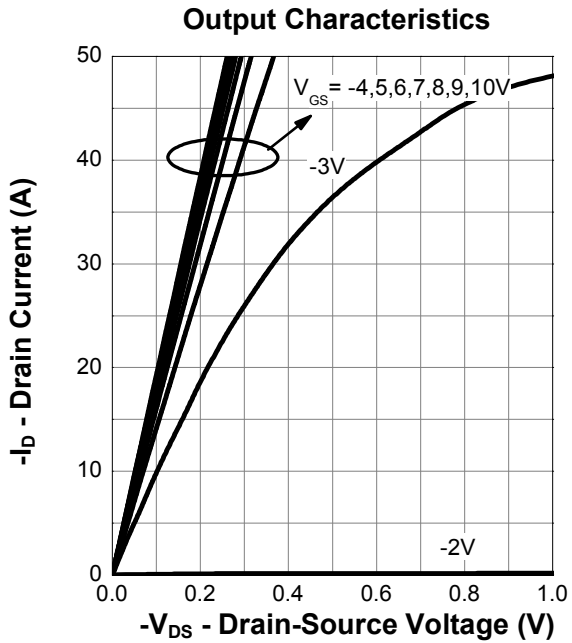

7. Typical Characteristics (cont.)

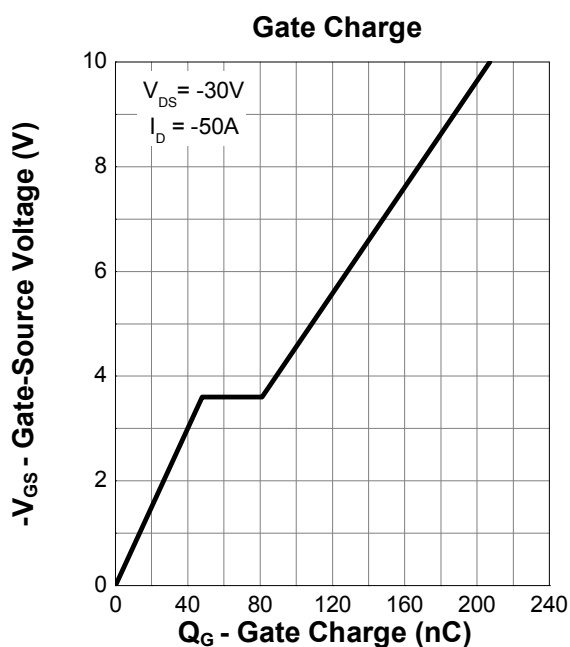
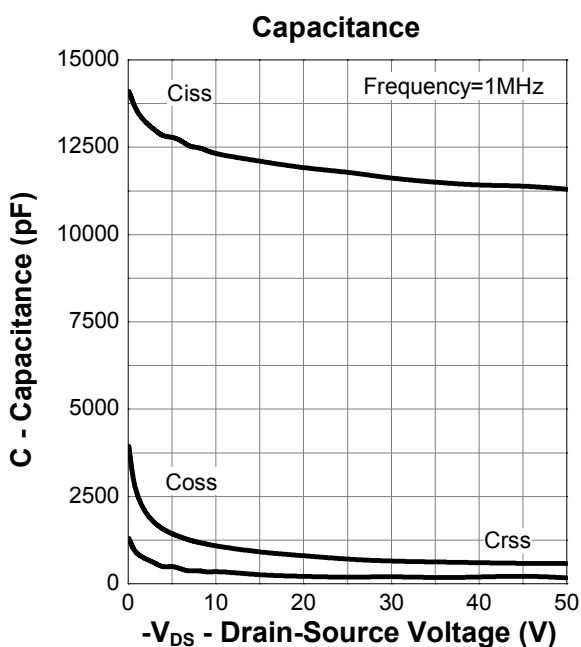
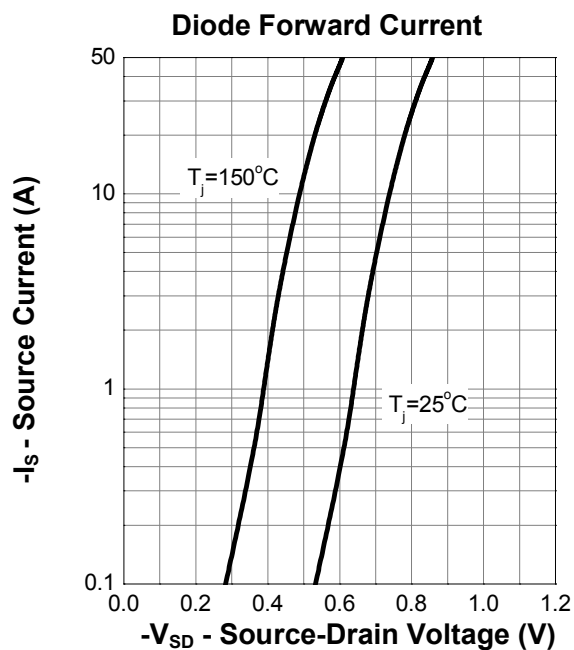
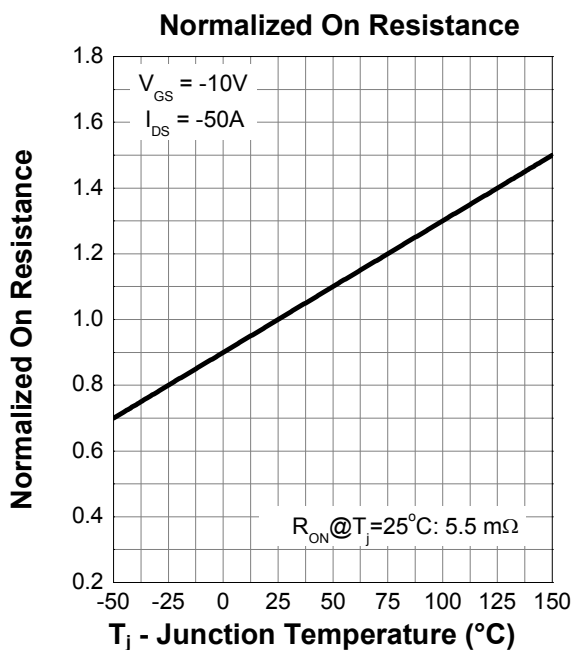

8.Package Dimensions

TO263-2L

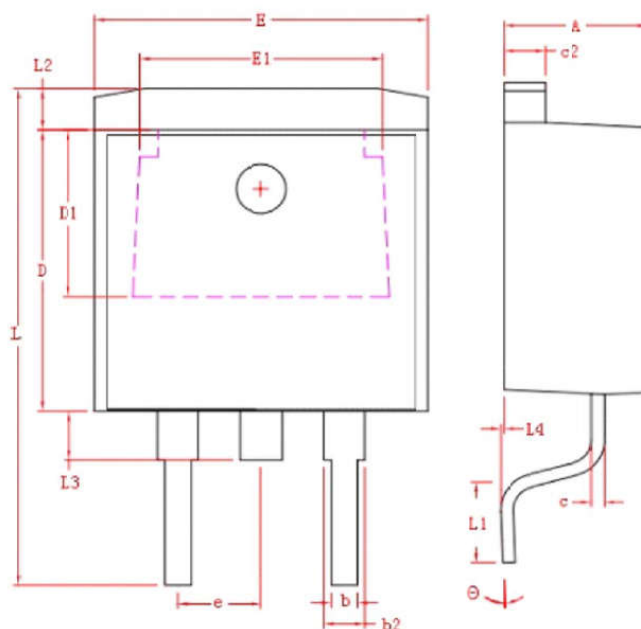

Symbol	Dimensions In Millimeters	
	MIN.	MAX.
A	4.40	4.80
b	0.76	1.00
L4	0.00	0.25
C	0.36	0.50
L3	1.50 REF	
L1	2.29	2.79
E	9.80	10.40
E1	7.40 REF	
c2	1.25	1.45
b2	1.17	1.47
D	8.60	9.00
D1	5.10 REF	
e	2.54 REF	
L	14.6	15.8
θ	$0^\circ \pm 3^\circ$	
L2	1.27 REF	