

N-Channel Enhancement Mode MOSFET

1. Product Information

1.1 Features

- Advanced trench cell design
- Low Thermal Resistance

1.2 Applications

- Motor drivers
- DC - DC Converter

1.3 Quick reference

- $BV \geq 40 \text{ V}$
- $R_{DS(ON)} \leq 2.0 \text{ m}\Omega @ V_{GS} = 10 \text{ V}$
- $P_{tot} \leq 166 \text{ W}$
- $R_{DS(ON)} \leq 3.5 \text{ m}\Omega @ V_{GS} = 4.5 \text{ V}$
- $I_D \leq 100 \text{ A}$

2. Pin Description

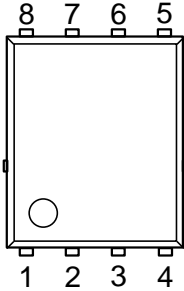
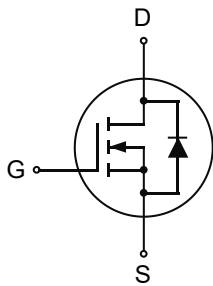
Pin	Description	Simplified Outline	Symbol
1,2,3	Source	 <p style="text-align: center;">Top View PDFN5x6-8L</p>	
4	Gate		
5,6,7,8	Drain		

3. Limiting Values

Symbol	Parameter	Conditions	Min	Max	Unit
V_{DS}	Drain-Source Voltage	$T_C = 25\text{ }^\circ\text{C}$	40	-	V
V_{GS}	Gate-Source Voltage	$T_C = 25\text{ }^\circ\text{C}$	-	± 20	V
$I_D^{*,***}$	Drain Current	$T_C = 25\text{ }^\circ\text{C}, V_{GS} = 10\text{ V}$	-	100	A
$I_{DM}^{*,**,***}$	Pulsed Source Current	$T_C = 25\text{ }^\circ\text{C}, V_{GS} = 10\text{ V}$	-	300	A
P_{tot}^*	Total Power Dissipation	$T_C = 25\text{ }^\circ\text{C}$	-	166	W
T_{stg}	Storage Temperature		- 55	150	$^\circ\text{C}$
T_J	Junction Temperature		-	150	$^\circ\text{C}$
I_S	Diode Forward Current	$T_C = 25\text{ }^\circ\text{C}$	-	100	A
$R_{\theta JA}^*$	Thermal Resistance- Junction to Ambient		-	62.5	$^\circ\text{C} / \text{W}$
$R_{\theta JC}^*$	Thermal Resistance- Junction to Case		-	0.75	

Notes:

- * Surface Mounted on 1 in² pad area, $t \leq 10\text{ sec}$
- ** Pulse width $\leq 10\text{ }\mu\text{s}$, duty cycle $\leq 1\%$
- *** Limited by bonding wire

4. Marking Information

Product Name	Marking
KJ40H100G	<div style="display: inline-block; background-color: black; color: white; padding: 2px;">40H100 YWWXXX</div> YWWXXX: Date Code

5. Ordering Code

Product Name	Package	Reel Size	Tape width	Quantity	Note
KJ40H100G	PDFN5x6-8L	-	-	5000	

Note: KUIJIEXIN defines "Green" as lead-free (RoHS compliant) and halogen free (Br or Cl does not exceed 900 ppm by weight in homogeneous material and total of Br and Cl does not exceed 1500 ppm by weight; Follow IEC 61249-2-21 and IPC / JEDEC J-STD-020C)

6. Electrical Characteristics (T_A=25°C Unless Otherwise Noted)

Symbol	Parameter	Conditions	Min	Typ	Max	Unit
Static Characteristics						
B _V DSS	Drain-Source Breakdown Voltage	V _{GS} = 0 V, I _D = 250 μA	40	-	-	V
V _{GS(th)}	Gate Threshold Voltage	V _{DS} = V _{GS} , I _{DS} = 250 μA	1.5	2.0	2.5	V
I _{DSS}	Zero Gate Voltage Source Current	V _{DS} = 32 V, V _{GS} = 0 V	-	-	1	μA
		T _J = 85 °C	-	-	30	μA
I _{GSS}	Gate Leakage Current	V _{GS} = ± 20 V, V _{DS} = 0 V	-	-	± 100	nA
R _{DS(ON)} ^a	Drain-Source On-State Resistance	V _{GS} = 10 V, I _D = 20 A	-	1.5	2.0	mΩ
		V _{GS} = 4.5 V, I _D = 10 A	-	2.9	3.5	
Diode Characteristics						
V _{SD} ^a	Diode Forward Voltage	I _{SD} = 20 A, V _{GS} = 0 V	-	0.7	1.3	V
t _{rr}	Reverse Recovery Time	I _{SD} = 20 A, dI _{SD} /dt = 100 A/μs	-	42	-	ns
Q _{rr}	Reverse Recovery Charge		-	39	-	nC
Dynamic Characteristics^b						
C _{iss}	Input Capacitance	V _{GS} = 0 V, V _{DS} = 20 V Frequency = 1 MHz	-	10861	-	pF
C _{oss}	Output Capacitance		-	757	-	
C _{rss}	Reverse Transfer Capacitance		-	165	-	
t _{d(on)}	Turn-on Delay Time	V _{DS} = 20 V, V _{GEN} = 10 V, R _G = 4.5 Ω, R _L = 1 Ω, I _D = 20 A	-	32	-	ns
t _r	Turn-on Rise Time		-	73	-	
t _{d(off)}	Turn-off Delay Time		-	119	-	
t _f	Turn-off Fall Time		-	84	-	
Gate Charge Characteristics^b						
Q _g	Total Gate Charge	V _{GS} = 10 V, V _{DS} = 20 V, I _{DS} = 20 A	-	163	-	nC
Q _{gs}	Gate-Source Charge		-	48.2	-	
Q _{gd}	Gate-Drain Charge		-	25.6	-	

Notes :

a : Pulse test ; pulse width ≤ 300 μs, duty cycle ≤ 2 %

b : Guaranteed by design, not subject to production testing

7. Typical Characteristics

Power Capability

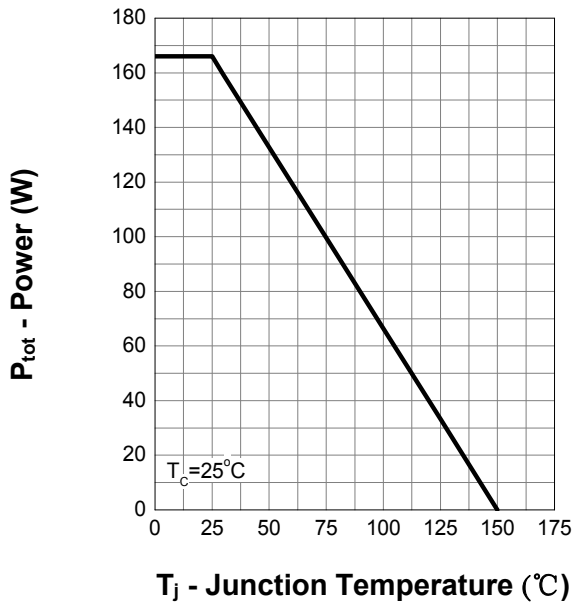

Current Capability

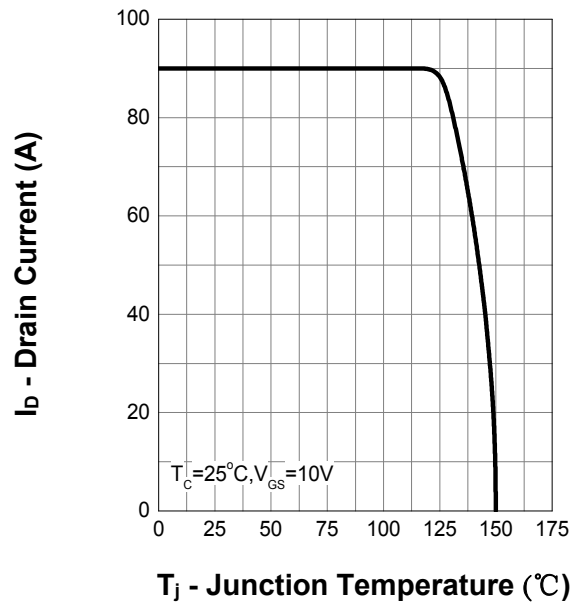

Safe Operation Area

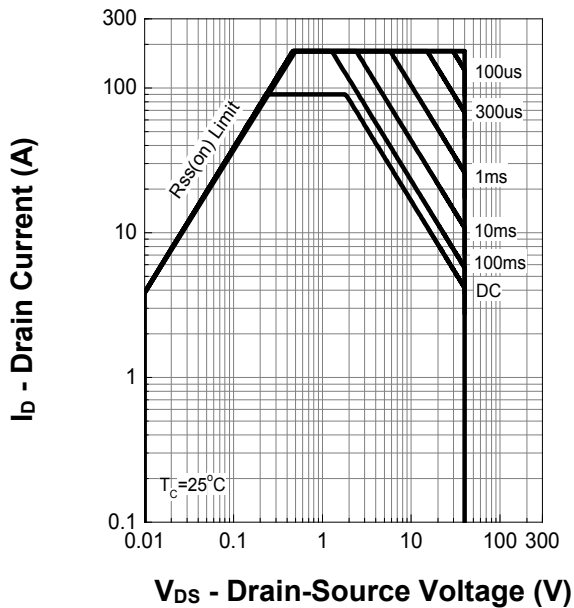

Thermal Transient Impedance

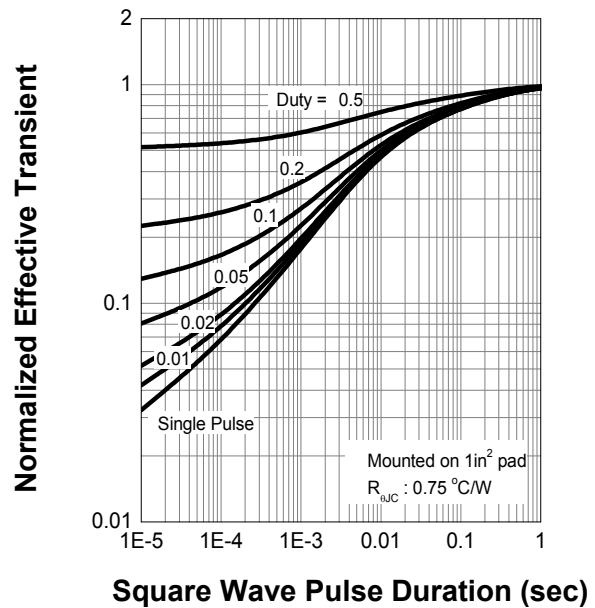

7. Typical Characteristics (Cont.)

Output Characteristics

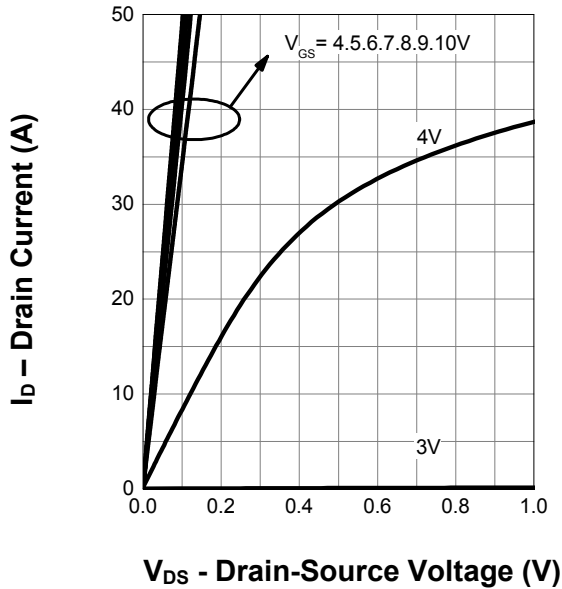

Drain-Source On Resistance

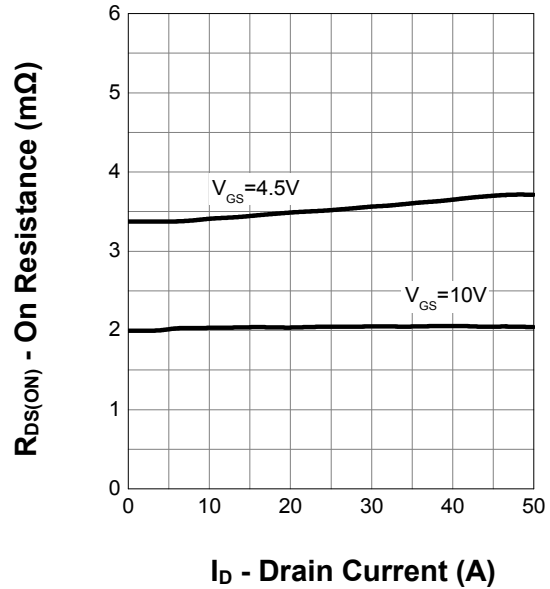

Transfer Characteristics

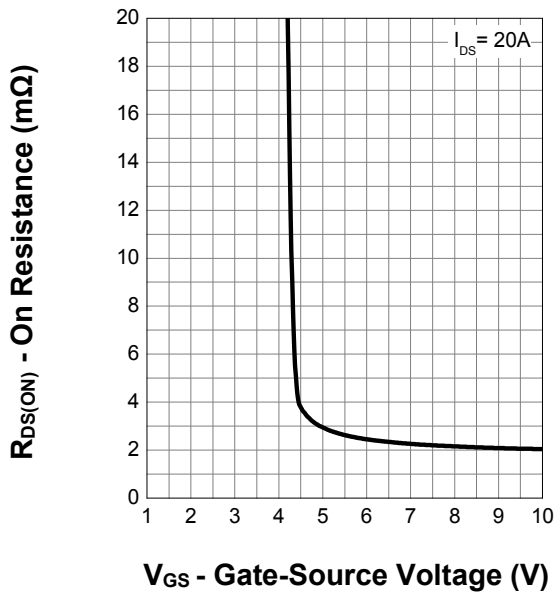

Gate Threshold Voltage

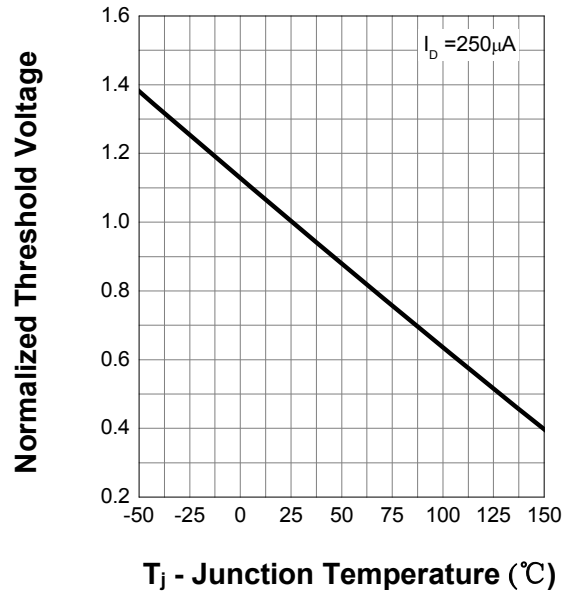

7. Typical Characteristics (Cont.)

Drain-Source On Resistance

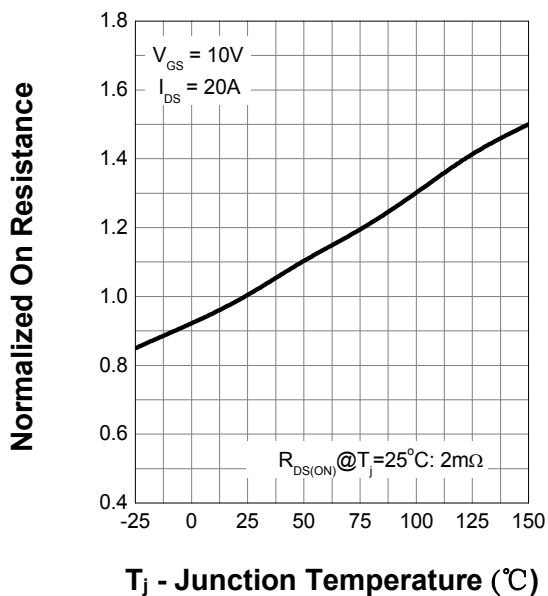

Body Diode Characteristics

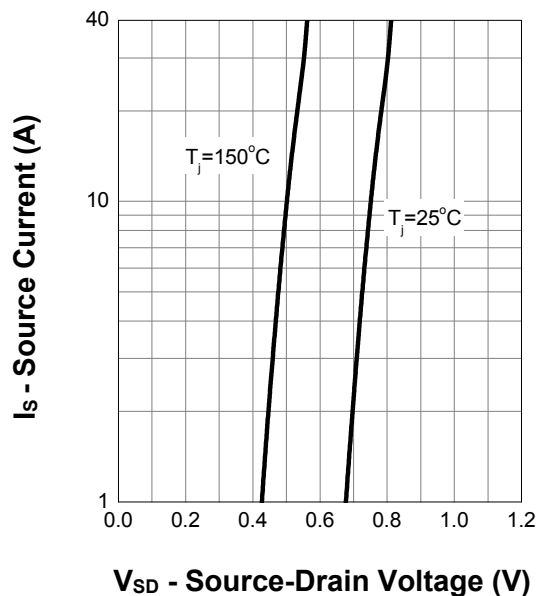

Capacitance

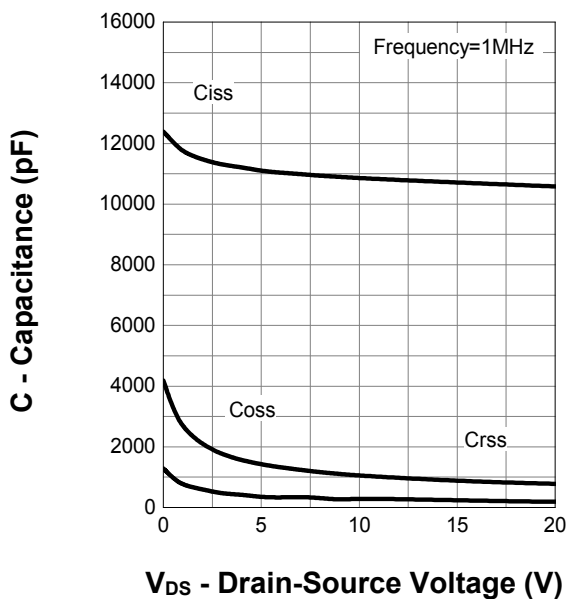

Gate Charge

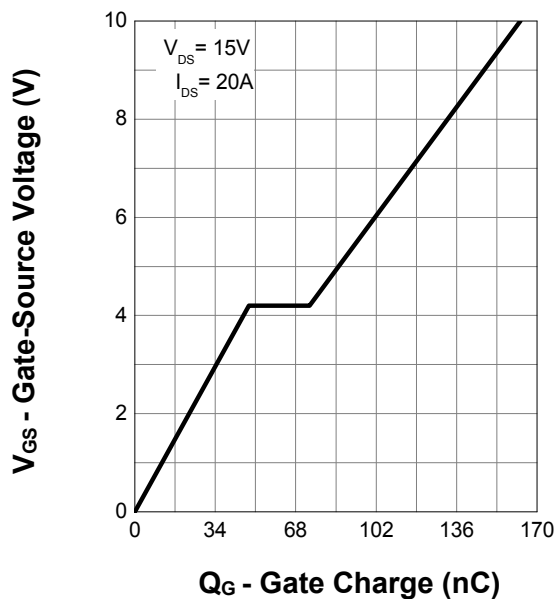

8. Package Dimensions

PDFN5x6-8L Package

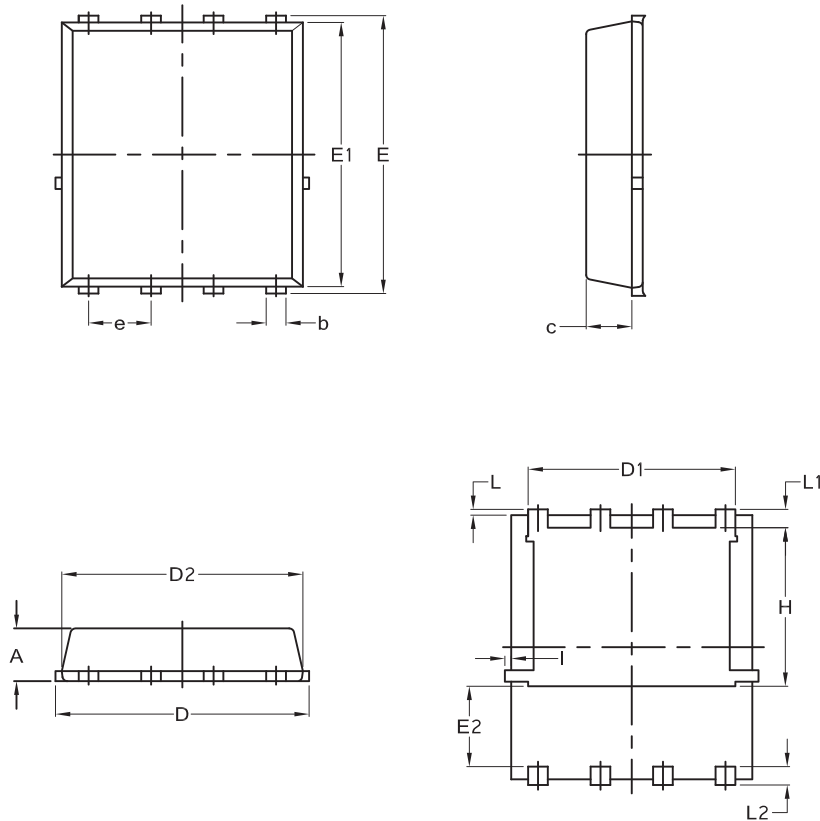

Symbol	Dimensions In Millimeters		Dimensions In Inches	
	Min.	Max.	Min.	Max.
A	1.03	1.17	0.0406	0.0461
b	0.34	0.48	0.0134	0.0189
c	0.824	0.970	0.0324	0.0382
D	4.80	5.40	0.1890	0.2126
D1	4.11	4.31	0.1618	0.1697
D2	4.80	5.00	0.1890	0.1969
E	5.95	6.15	0.2343	0.2421
E1	5.65	5.85	0.2224	0.2303
E2	1.60	-	0.0630	-
e	1.270 BSC		0.050 BSC	
L	0.05	0.25	0.0020	0.0098
L1	0.38	0.50	0.0150	0.0197
L2	0.38	0.50	0.0150	0.0197
H	3.30	3.50	0.1299	0.1378
I	-	0.18	-	0.0070