

N-Channel Enhancement Mode MOSFET

1. Product Information

1.1 Features

- Surface-mounted package
- Advanced trench cell design

1.2 Applications

- LCD TV appliances
- High power inverter system
- LCDM appliances

1.3 Quick reference

- $BV \cong 60\text{ V}$
- $R_{DS(ON)} \leq 14\text{m}\Omega @ V_{GS} = 10\text{ V}$
- $P_{tot} \leq 35\text{ W}$
- $R_{DS(ON)} \leq 26\text{m}\Omega @ V_{GS} = 4.5\text{ V}$
- $I_D \leq 50\text{ A}$

2. Pin Description

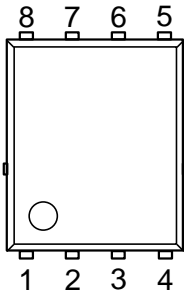
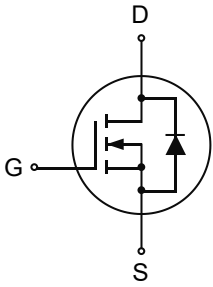
Pin	Description	Simplified Outline	Symbol
1,2,3	Source	 <p style="text-align: center;">Top View PDFN5x6-8L</p>	
4	Gate		
5,6,7,8	Drain		

3. Limiting Values

Symbol	Parameter	Conditions	Min	Max	Unit
V_{DS}	Drain-Source Voltage	$T_C = 25\text{ }^\circ\text{C}$	-	60	V
V_{GS}	Gate-Source Voltage	$T_C = 25\text{ }^\circ\text{C}$	-	± 20	V
I_D	Drain Current (DC)	$T_C = 25\text{ }^\circ\text{C}, V_{GS} = 10\text{ V}$	-	50	A
		$T_C = 100\text{ }^\circ\text{C}, V_{GS} = 10\text{ V}$	-	25	A
$I_{DM}^{*,***}$	Drain Current (Pulsed)	$T_C = 25\text{ }^\circ\text{C}, V_{GS} = 10\text{ V}$	-	120	A
P_{tot}	Drain power dissipation	$T_C = 25\text{ }^\circ\text{C}$	-	35	W
T_{stg}	Storage Temperature		-55	150	$^\circ\text{C}$
T_J	Junction Temperature		-	150	$^\circ\text{C}$
I_S	Continuous-Source Current	$T_C = 25\text{ }^\circ\text{C}$	-	24	A
$R_{\theta JA}^{**}$	Thermal Resistance- Junction to Ambient		-	50	$^\circ\text{C/W}$
$R_{\theta JC}^{**}$	Thermal Resistance- Junction to Case		-	3.5	

Notes :

* Pulse width $\leq 300\text{ }\mu\text{s}$, duty cycle $\leq 2\%$

** Mounted on Large Heat Sink

*** Limited by bonding wire

4. Marking Information

Product Name	Marking
KJ1206GM	<div style="display: inline-block; border: 1px solid black; padding: 2px;"> 1206M YWWXXX </div> YWW : Date Code

5. Ordering Code

Product Name	Package	Reel Size	Tape width	Quantity	Note
KJ1206GM	PDFN5x6-8L			4000	

Note: KUIJIEXIN defines " Green " as lead-free (RoHS compliant) and halogen free (Br or Cl does not exceed 900 ppm by weight in homogeneous material and total of Br and Cl does not exceed 1500 ppm by weight; Follow IEC 61249-2-21 and IPC / JEDEC J-STD-020C)

6. Electrical Characteristics (T_A = 25°C Unless Otherwise Noted)

Symbol	Parameter	Conditions	Min	Typ	Max	Unit
Static Characteristics						
BV _{DSS}	Drain-Source Breakdown Voltage	V _{GS} = 0 V, I _{DS} = 250 μA	60	-	-	V
V _{GS(th)}	Gate Threshold Voltage	V _{DS} = V _{GS} , I _{DS} = 250 μA	1.5	-	2.5	V
I _{DSS}	Drain Leakage Current	V _{DS} = 48 V, V _{GS} = 0 V	-	-	1	μA
I _{GSS}	Gate Leakage Current	V _{GS} = 0 V, V _{GS} = ± 20 V	-	-	±100	nA
R _{DS(ON)} ^a	On-State Resistance	V _{GS} = 10 V, I _{DS} = 12 A	-	11	14	mΩ
		V _{GS} = 4.5 V, I _{DS} = 8 A	-	20	26	
Diode Characteristics						
V _{SD} ^a	Diode Forward Voltage	I _{SD} = 12 A, V _{GS} = 0 V	-	-	1.3	V
t _{rr}	Reverse Recovery Time	I _{DS} = 12 A, V _{GS} = 0 V dI _{SD} /dt = 100 A/μs	-	31	-	nS
Q _{rr}	Reverse Recovery Charge		-	11	-	μC
Dynamic Characteristics^b						
C _{iss}	Input Capacitance	V _{GS} = 0 V, V _{DS} = 30 V Frequency = 1 MHz	-	757	-	pF
C _{oss}	Output Capacitance		-	340	-	
C _{rss}	Reverse Transfer Capacitance		-	28	-	
t _{d(on)}	Turn-on Delay Time	V _{DS} = 30 V, V _{GEN} = 10 V, R _G = 4.5 Ω, R _L = 2.5 Ω, I _{DS} = 12 A	-	6.2	-	nS
t _r	Turn-on Rise Time		-	23	-	
t _{d(off)}	Turn-off Delay Time		-	13	-	
t _f	Turn-off Fall Time		-	17	-	
Gate Charge Characteristics^b						
Q _g	Total Gate Charge	V _{DS} = 30 V, V _{GS} = 10 V, I _{DS} = 12 A	-	15	-	nC
Q _{gs}	Gate-Source Charge		-	3.6	-	
Q _{gd}	Gate-Drain Charge		-	3.6	-	

Notes :

a : Pulse test ; pulse width ≤ 300 μs, duty cycle ≤ 2%

b : Guaranteed by design, not subject to production testing

7. Typical Characteristics (Cont.)

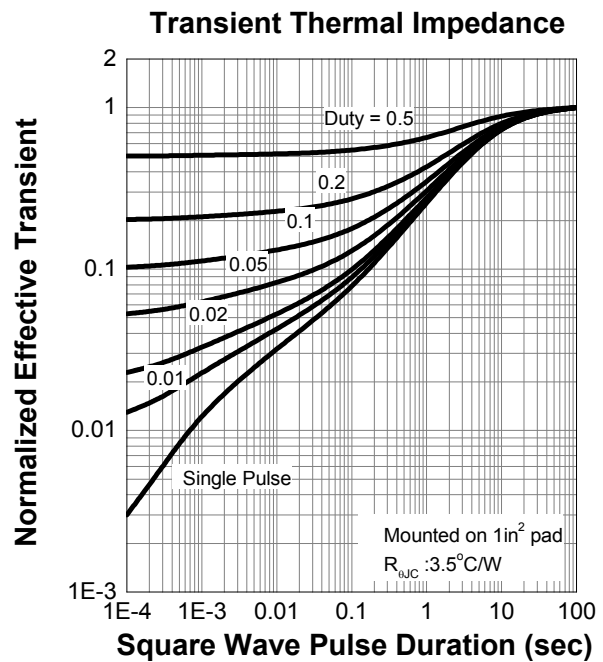
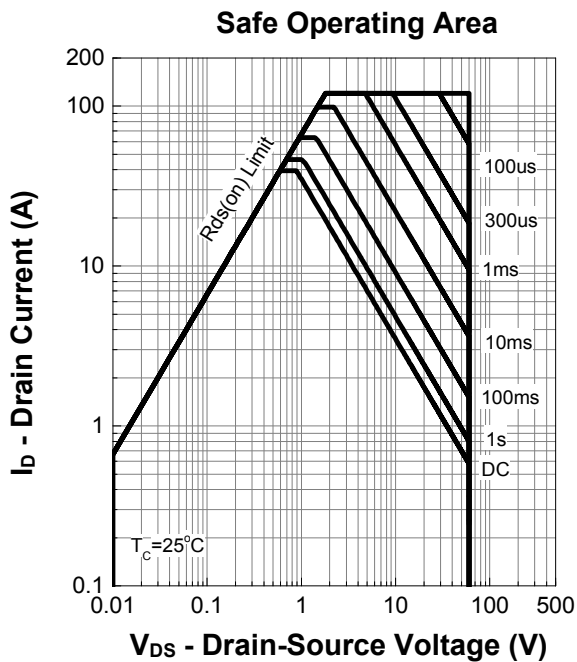
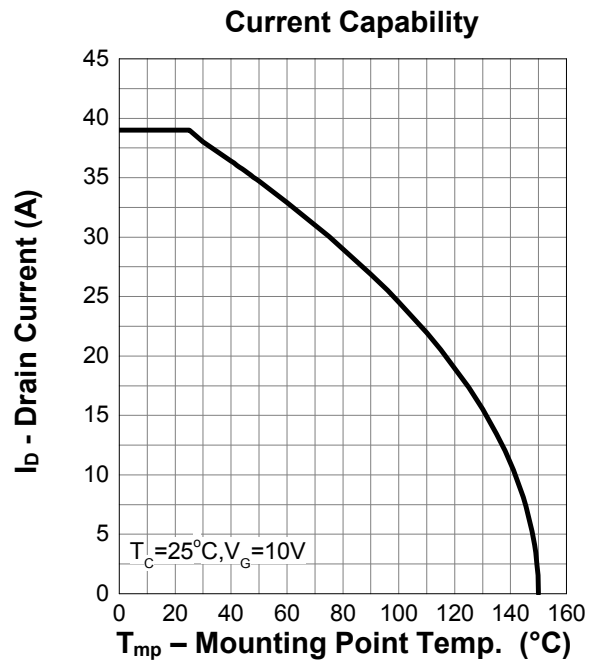
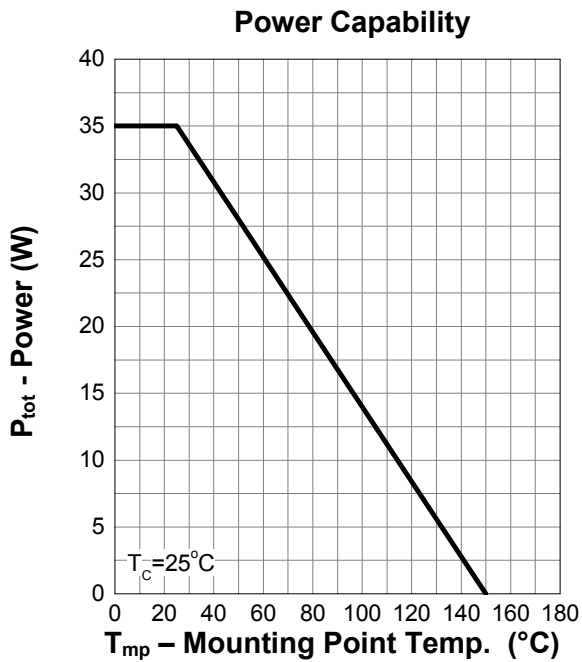

7. Typical Characteristics (Cont.)

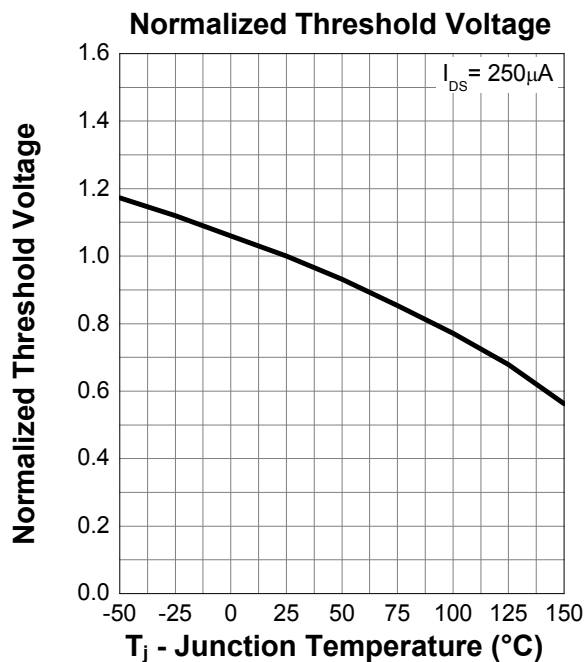
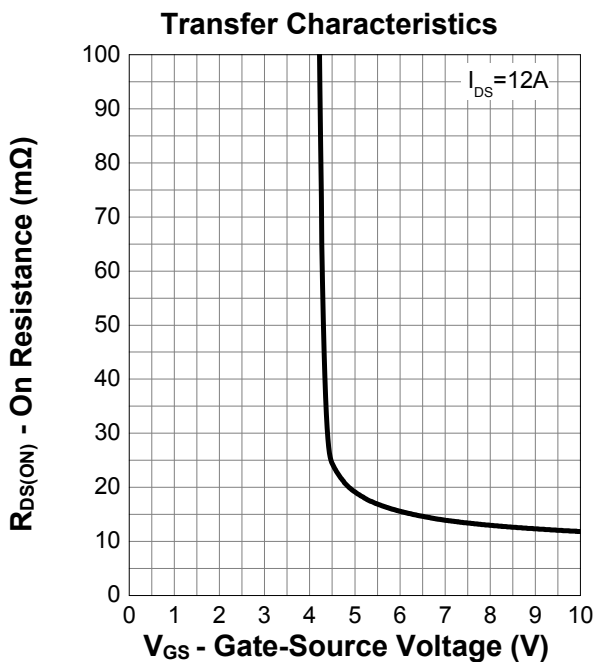
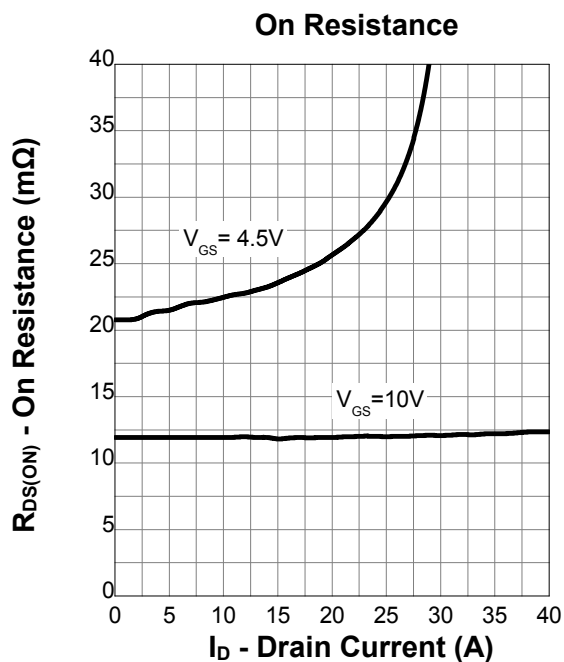
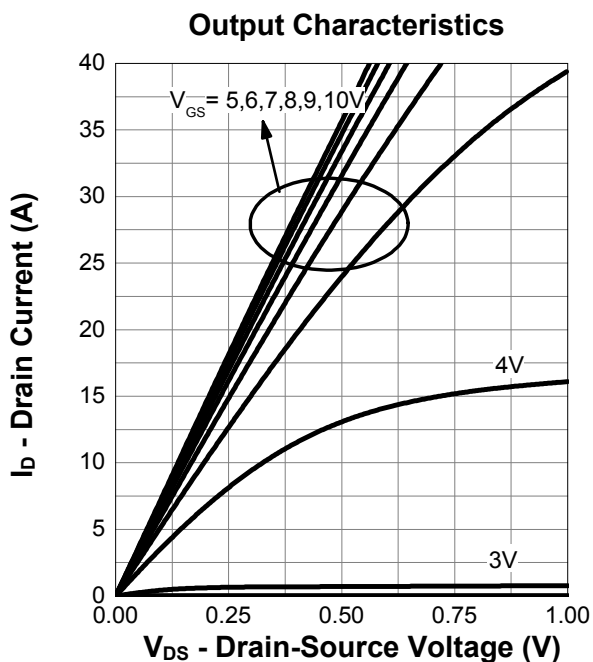

7. Typical Characteristics (Cont.)

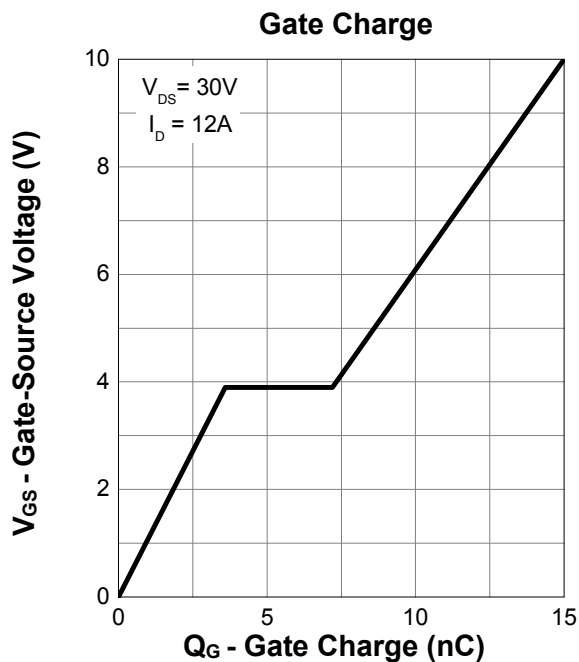
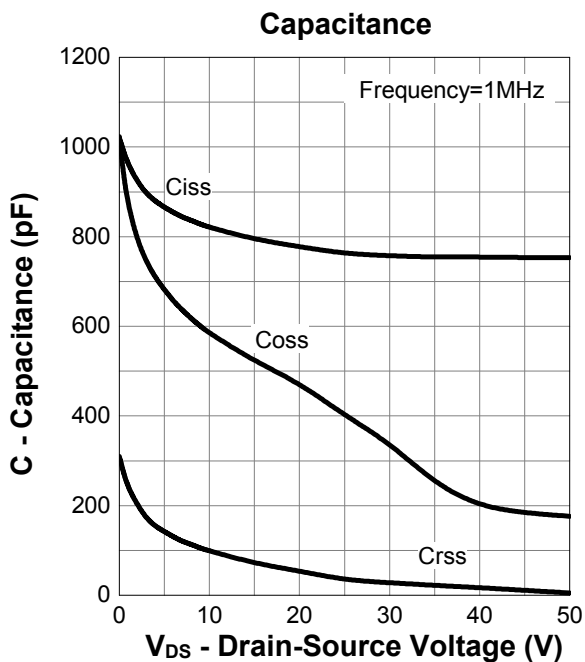
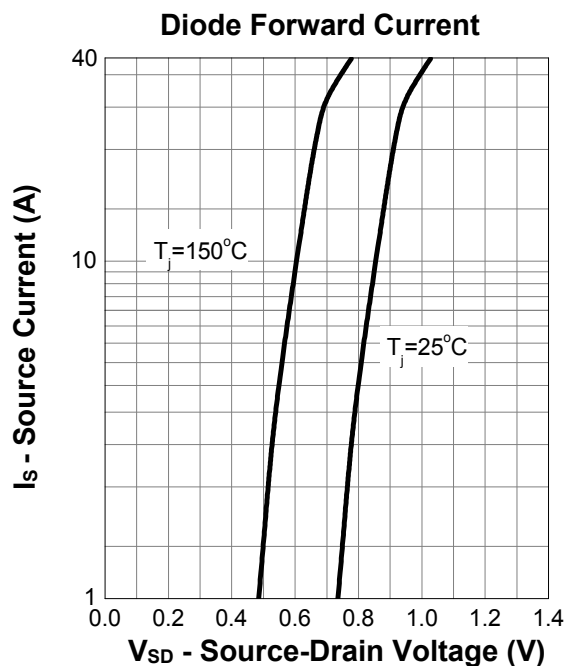
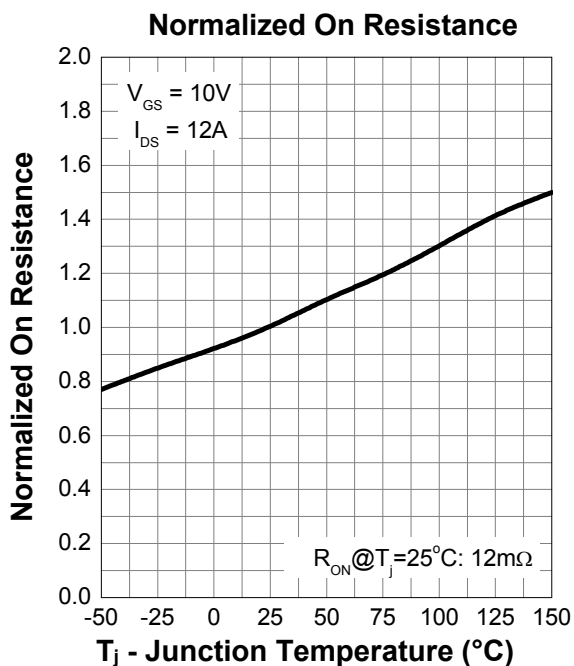

8. Package Dimensions

PDFN5x6-8L Package

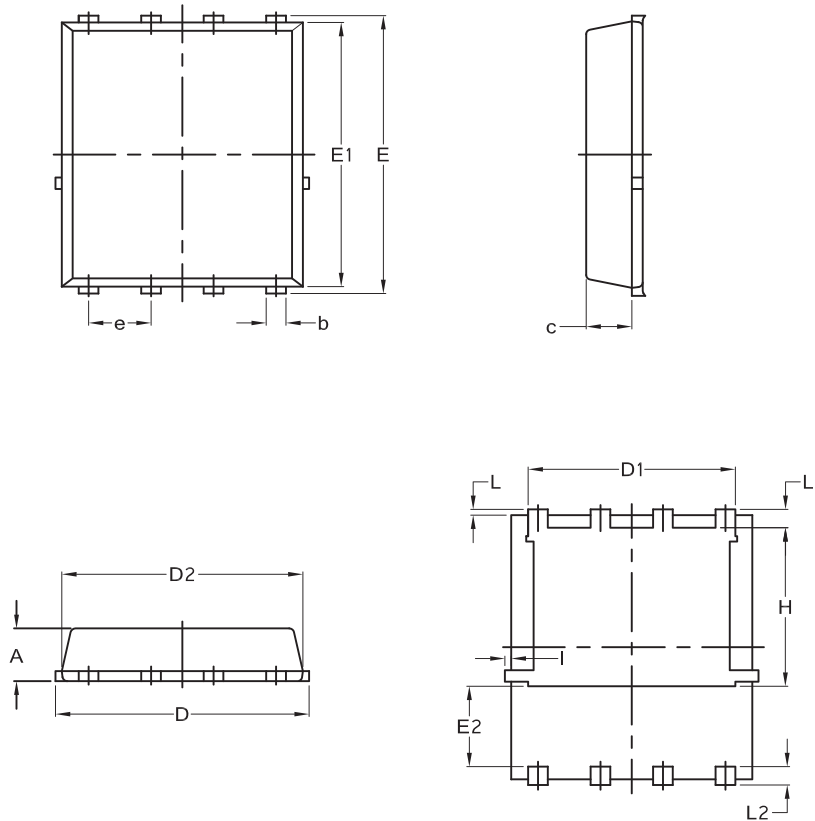

Symbol	Dimensions In Millimeters		Dimensions In Inches	
	Min.	Max.	Min.	Max.
A	1.03	1.17	0.0406	0.0461
b	0.34	0.48	0.0134	0.0189
c	0.824	0.970	0.0324	0.0382
D	4.80	5.40	0.1890	0.2126
D1	4.11	4.31	0.1618	0.1697
D2	4.80	5.00	0.1890	0.1969
E	5.95	6.15	0.2343	0.2421
E1	5.65	5.85	0.2224	0.2303
E2	1.60	-	0.0630	-
e	1.270 BSC		0.050 BSC	
L	0.05	0.25	0.0020	0.0098
L1	0.38	0.50	0.0150	0.0197
L2	0.38	0.50	0.0150	0.0197
H	3.30	3.50	0.1299	0.1378
I	-	0.18	-	0.0070