

N-Channel Enhancement Mode MOSFET

1. Product Information

1.1 Features

- Advanced trench cell design
- Low thermal resistance

1.2 Applications

- Motor drivers
- DC/DC converter

1.3 Quick reference

- $BV \geq 150\text{ V}$
- $R_{DS(ON)} \leq 2.8\text{ m}\Omega @V_{GS} = 10\text{ V}$
- $P_D \leq 375\text{ W}$
- $R_{DS(ON)} \leq 3.3\text{ m}\Omega @V_{GS} = 8\text{ V}$
- $I_D \leq 200\text{ A}$

2. Pin Description

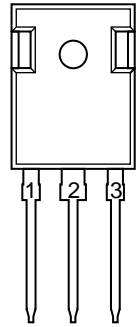
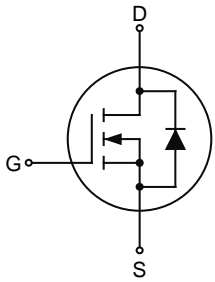
Pin	Description	Simplified Outline	Symbol
1	Gate (G)	 <p>Top View TO-247</p>	
2	Drain (D)		
3	Source (S)		

3. Limiting Values

Symbol	Parameter	Conditions	Min	Max	Unit
V_{DS}	Drain-Source Voltage	$T_C=25^{\circ}C$	-	150	V
V_{GS}	Gate-Source Voltage	$T_C=25^{\circ}C$	-	± 20	V
$I_D^{*,***}$	Drain Current (DC)	$T_C=25^{\circ}C, V_{GS}=10\text{ V}$	-	200	A
		$T_C=100^{\circ}C, V_{GS}=10\text{ V}$	-	172	A
$I_{DM}^{*,**}$	Drain Current (Pulsed)	$T_C=25^{\circ}C, V_{GS}=10\text{ V}$	-	800	A
P_D^*	Drain Power Dissipation	$T_C=25^{\circ}C$	-	375	W
I_S	Diode Forward Current	$T_C=25^{\circ}C$	-	200	A
E_{AS}^*	Single Pulsed Avalanche Energy	$V_{DD}=50\text{ V}, L=1.0\text{ mH}$	-	4050	mJ
T_J, T_{stg}	Operating Junction and Storage Temperature Range		-55	175	$^{\circ}C$
$R_{\theta JA}^*$	Thermal Resistance-Junction to Ambient		-	35	$^{\circ}C/W$
$R_{\theta JC}$	Thermal Resistance-Junction to Case		-	0.4	

Notes:

- * Surface mounted on 1 in² pad area, $t \leq 10\text{ sec}$.
- ** Pulse width $\leq 300\ \mu\text{s}$, duty cycle $\leq 2\%$.
- *** Limited by bonding wire.

4. Marking Information

Product Name	Marking
KJ028N15PH	<div style="display: inline-block; border: 1px solid black; padding: 5px;"> KJ028N15PH AYWWXX XXXXXX </div> YWWXX: Date Code

5. Ordering Code

Product Name	Package	Packaging	Quantity (pcs)	Note
KJ028N15PH	TO-247	Tube	30	

Note: KUIJIEXIN defines "Green" as lead-free (RoHS compliant) and halogen free (Br or Cl does not exceed 900 ppm by weight in homogeneous material and total of Br and Cl does not exceed 1500 ppm by weight; Follow IEC 61249-2-21 and IPC/JEDEC J-STD-020C)

6. Electrical Characteristics (T_A=25°C unless otherwise noted)

Symbol	Parameter	Conditions	Min	Typ	Max	Unit
Static Characteristics						
BV _{DSS}	Drain-Source Breakdown Voltage	V _{GS} =0 V, I _{DS} =250 μA	150	-	-	V
V _{GS(th)}	Gate Threshold Voltage	V _{DS} =V _{GS} , I _{DS} =250 μA	3	-	5	V
I _{DSS}	Drain Leakage Current	V _{DS} =150 V, V _{GS} =0 V	-	-	1	μA
I _{GSS}	Gate Leakage Current	V _{DS} =0 V, V _{GS} =±20 V	-	-	±100	nA
R _{DS(ON)} ^a	On-State Resistance	V _{GS} =10 V, I _{DS} =50 A	-	2.3	2.8	mΩ
		V _{GS} =8 V, I _{DS} =30 A	-	2.5	3.3	mΩ
Diode Characteristics						
V _{SD} ^a	Diode Forward Voltage	V _{GS} =0 V, I _{SD} =50 A	-	-	1.3	V
t _{rr}	Reverse Recovery Time	V _{GS} =0 V, I _{SD} =50 A, dI _{SD} /dt=100 A/μs	-	199	-	ns
Q _{rr}	Reverse Recovery Charge		-	801	-	nC
Dynamic Characteristics^b						
C _{iss}	Input Capacitance	V _{DS} =75 V, V _{GS} =0 V, Frequency=1 MHz	-	19907	-	pF
C _{oss}	Output Capacitance		-	1540	-	
C _{rss}	Reverse Transfer Capacitance		-	185	-	
t _{d(on)}	Turn-on Delay Time	V _{DS} =75 V, V _{GEN} =10 V, R _G =3.9 Ω, R _L =1.5 Ω, I _{DS} =50 A	-	74	-	ns
t _r	Turn-on Rise Time		-	120	-	
t _{d(off)}	Turn-off Delay Time		-	109	-	
t _f	Turn-off Fall Time		-	134	-	
Gate Charge Characteristics^b						
Q _g	Total Gate Charge	V _{DS} =75 V, V _{GS} =10 V, I _{DS} =50 A	-	283	-	nC
Q _{gs}	Gate-Source Charge		-	129	-	
Q _{gd}	Gate-Drain Charge		-	60	-	

Notes:

- Pulse test; pulse width ≤ 300 μs, duty cycle ≤ 2%.
- Guaranteed by design, not subject to production testing.

7. Typical Characteristics

Power Capability

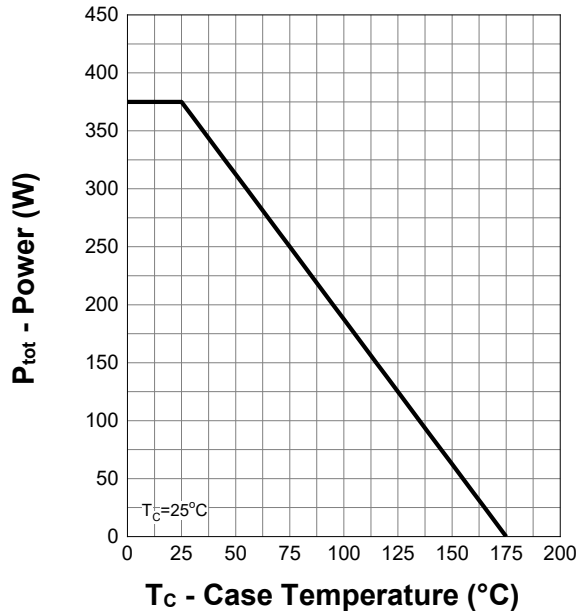

Current Capability

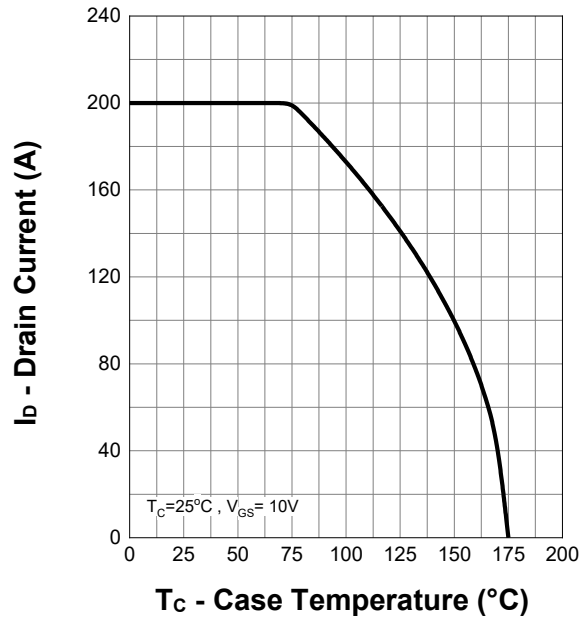

Safe Operating Area

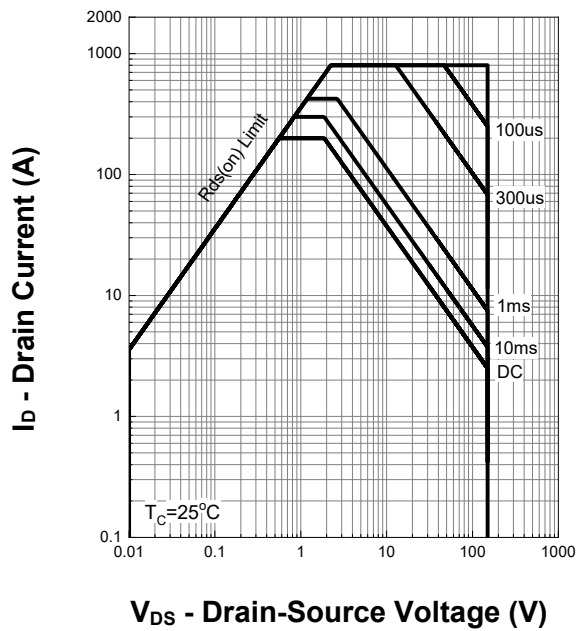

Transient Thermal Impedance

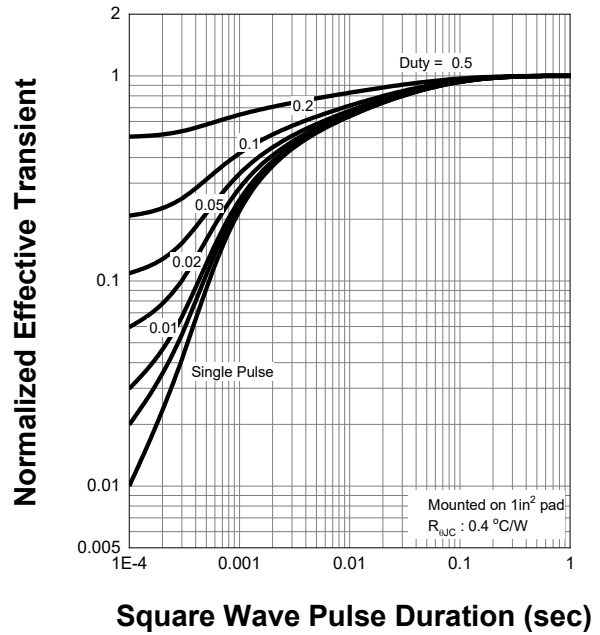

7. Typical Characteristics (cont.)

Output Characteristics

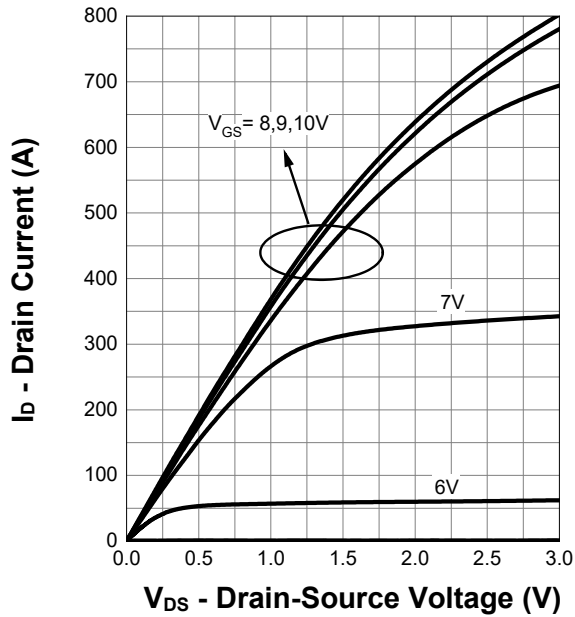

On Resistance

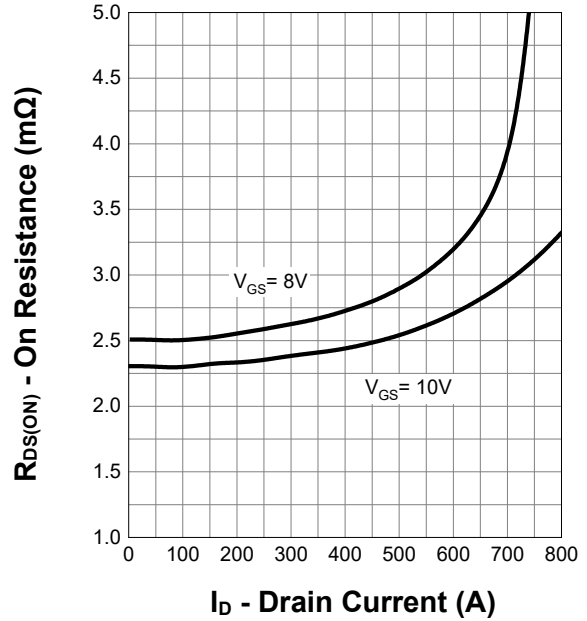

Transfer Characteristics

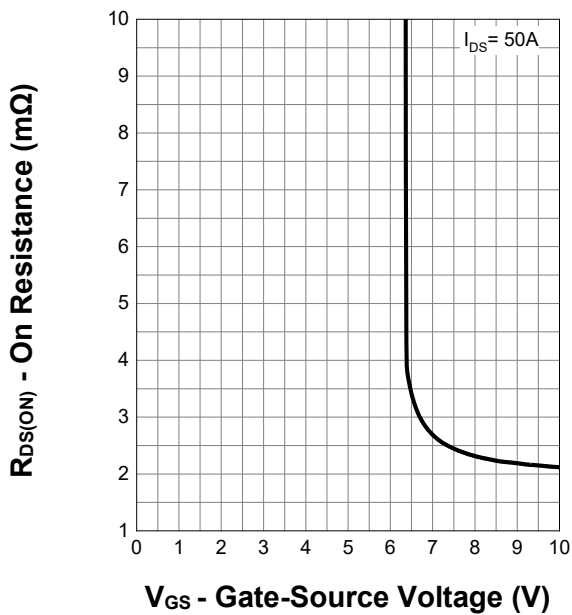

Normalized Threshold Voltage

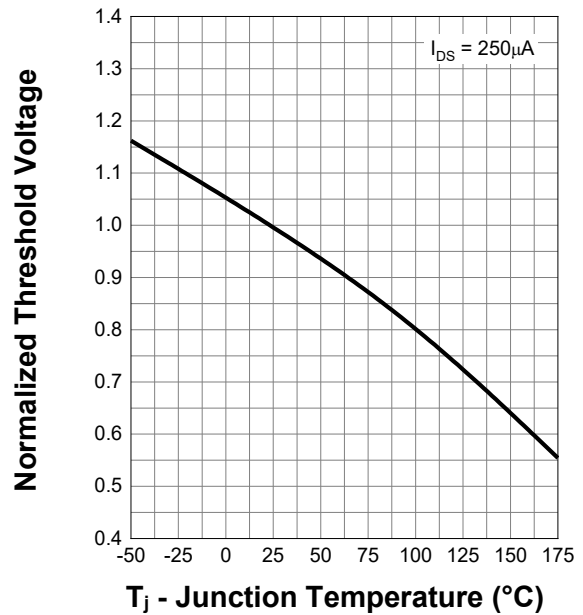

7. Typical Characteristics (cont.)

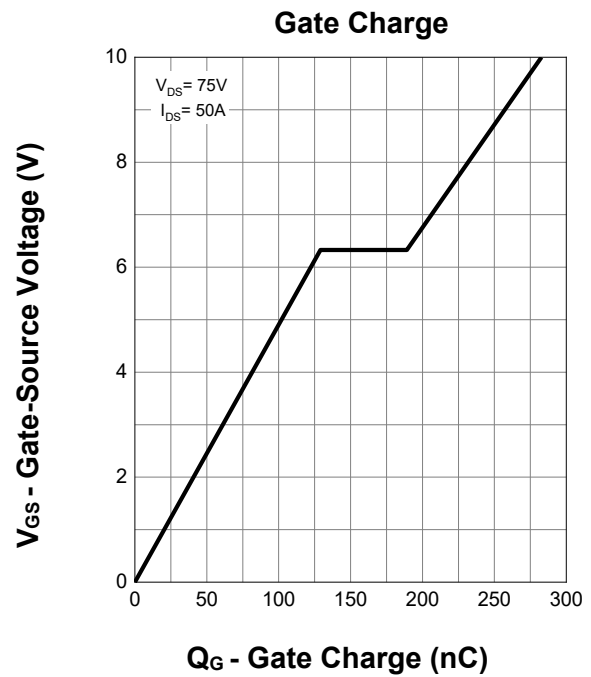
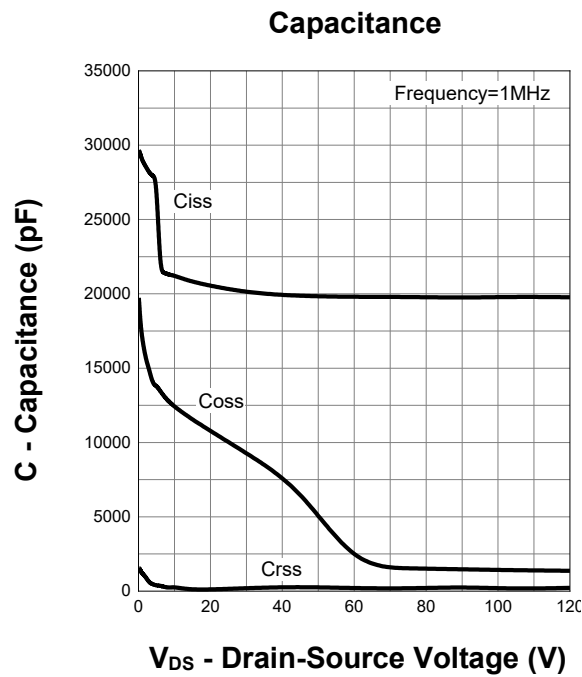
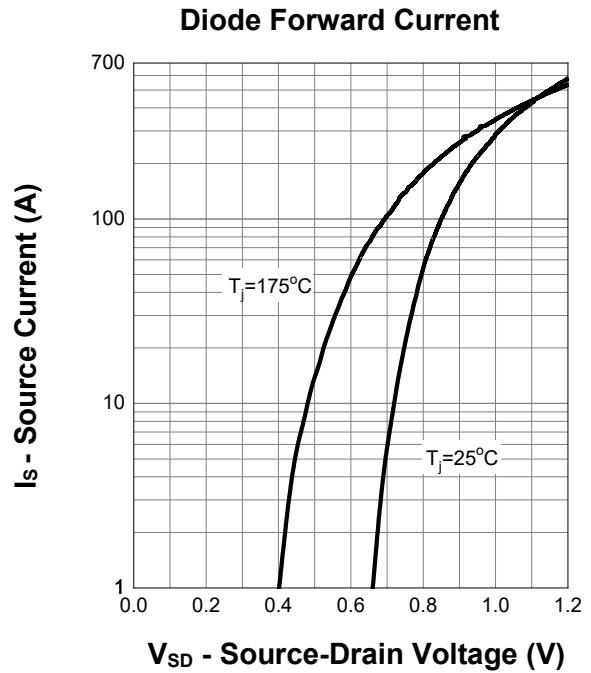
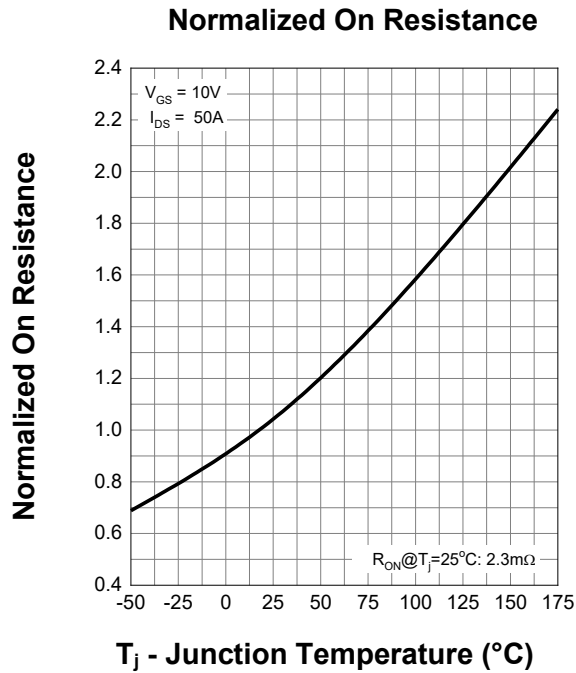

8. Package Dimensions

TO-247 Package

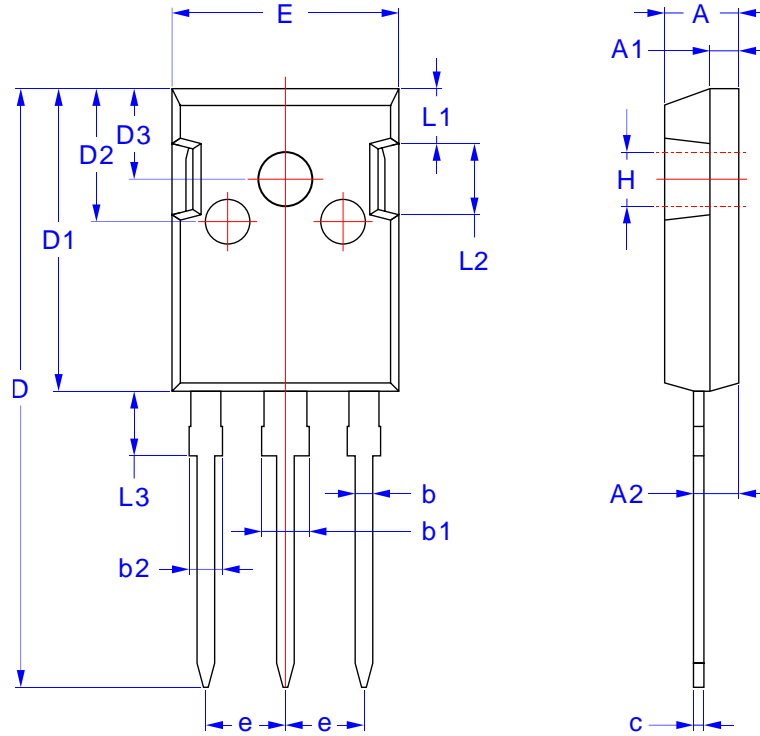

Symbol	Dimensions in Millimeters		Dimensions in Inches	
	MIN.	MAX.	MIN.	MAX.
A	4.90	5.10	0.1929	0.2008
A1	1.90	2.10	0.0748	0.0827
A2	2.00	3.00	0.0787	0.1181
b	0.55	0.75	0.0217	0.0295
b1	2.50	3.50	0.0984	0.1378
b2	1.75	2.50	0.0689	0.0984
c	1.20	1.30	0.0472	0.0512
D	41.00	42.00	1.6142	1.6535
D1	20.00	21.00	0.7874	0.8268
D2	8.00	10.00	0.3150	0.3937
D3	5.00	6.00	0.1969	0.2362
E	15.00	16.00	0.5906	0.6299
e	TYP 5.08		TYP 0.2000	
H	3.00	3.50	0.1181	0.1378
L1	3.50	4.00	0.1378	0.1575
L2	4.75	5.25	0.1870	0.2067
L3	4.00	5.00	0.1575	0.1969