

N-Channel Enhancement Mode MOSFET

1. Product Information

1.1 Features

- Advanced trench cell design
- Low thermal impedance
- Low gate charge

1.2 Applications

- DC/DC Converter
- Power Switch
- BMS

1.3 Quick reference

- $BV \geq 100\text{ V}$
- $R_{DS(ON)} \leq 4.5\text{ m}\Omega @V_{GS} = 10\text{ V}$
- $P_D \leq 156\text{ W}$
- $I_D \leq 120\text{ A}$

2. Pin Description

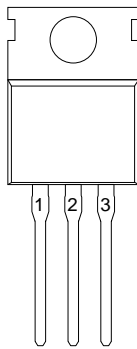
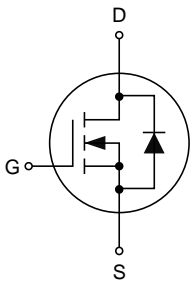
Pin	Description	Simplified Outline	Symbol
1	Gate	 <p>Top View TO-220</p>	
2	Source		
3	Drain		

3. Limiting Values

Symbol	Parameter	Conditions	Min	Max	Unit
V _{DS}	Drain-Source Voltage	T _C =25°C	100	-	V
V _{GS}	Gate-Source Voltage	T _C =25°C	-	±20	V
I _D *	Continuous Drain Current	T _C =25°C, V _{GS} =10 V	-	120	A
		T _C =100°C, V _{GS} =10 V	-	88	A
I _{DM} ***	Pulsed Drain Current	T _C =25°C, V _{GS} =10 V	-	480	A
P _D	Drain Power Dissipation	T _C =25°C	-	156	W
E _{AS}	Single Pulsed Avalanche Energy	V _{DD} =50 V, L=0.3 mH	-	430	mJ
T _J , T _{stg}	Operating Junction and Storage Temperature Range		-55	150	°C
R _{θJA} **	Thermal Resistance-Junction to Ambient		-	53	°C/W
R _{θJC} **	Thermal Resistance-Junction to Case		-	0.8	

Notes:

- * Pulse width ≤ 300 μs, duty cycle ≤ 2%.
- ** Surface mounted on 1 in² pad area, t ≤ 10 sec.
- *** Pulse width limited by maximum junction temperature.

4. Marking Information

Product Name	Marking
KJ045N10CA	<div style="display: inline-block; background-color: black; color: white; padding: 2px;"> KJ045N10CA YWWXXX </div> YWWXXX: Date Code

Ordering Code

Product Name	Package	Packaging	Quantity (pcs)	Note
KJ045N10CA	TO-220	Tube	50	

Note: KUAJIEXIN defines "Green" as lead-free (RoHS compliant) and halogen free (Br or Cl does not exceed 900 ppm by weight in homogeneous material and total of Br and Cl does not exceed 1500 ppm by weight; Follow IEC 61249-2-21 and IPC/JEDEC J-STD-020C)

6. Electrical Characteristics (T_J=25°C unless otherwise noted)

Symbol	Parameter	Conditions	Min	Typ	Max	Unit
Static Characteristics						
BV _{DSS}	Drain-Source Breakdown Voltage	V _{GS} =0 V, I _{DS} =250 μA	100	-	-	V
V _{GS(th)}	Gate Threshold Voltage	V _{DS} =V _{GS} , I _{DS} =250 μA	2.4	-	3.6	V
I _{DSS}	Drain Leakage Current	V _{DS} =100 V, V _{GS} =0 V	-	-	1	μA
I _{GSS}	Gate Leakage Current	V _{DS} =0 V, V _{GS} =±20 V	-	-	±100	nA
R _{DS(ON)} ^a	On-State Resistance	V _{GS} =10 V, I _{DS} =30 A	-	4.0	4.5	mΩ
g _{FS} ^b	Forward Transconductance	V _{GS} =5 V, I _{DS} =30 A	-	125	-	S
R _g	Gate Resistance	f=1 MHz	-	1.4	-	Ω
Diode Characteristics						
V _{SD} ^a	Diode Forward Voltage	V _{GS} =0 V, I _{SD} =30 A	-	0.9	1.2	V
t _{rr}	Reverse Recovery Time	V _{DS} =50 V, I _{DS} =30 A, V _{GS} =0 V, dI _{SD} /dt=100 A/μs	-	50	-	ns
Q _{rr}	Reverse Recovery Charge		-	108	-	nC
Dynamic Characteristics^b						
C _{iss}	Input Capacitance	V _{DS} =50 V, V _{GS} =10 V, Frequency=1 MHz	-	4874	-	pF
C _{oss}	Output Capacitance		-	665	-	
C _{rss}	Reverse Transfer Capacitance		-	144	-	
t _{d(on)}	Turn-on Delay Time	V _{DS} =50 V, V _{GEN} =10 V, R _G =6 Ω, I _{DS} =30 A	-	63	-	ns
t _r	Turn-on Rise Time		-	70	-	
t _{d(off)}	Turn-off Delay Time		-	86	-	
t _f	Turn-off Fall Time		-	41	-	
Gate Charge Characteristics^b						
Q _g	Total Gate Charge	V _{DS} =50 V, V _{GS} =10 V, I _{DS} =30 A	-	80	-	nC
Q _{gs}	Gate-Source Charge		-	22	-	
Q _{gd}	Gate-Drain Charge		-	25	-	

Notes:

a. Pulse test; pulse width ≤ 300 μs, duty cycle ≤ 2%.

b. Guaranteed by design, not subject to production testing.

7. Typical Characteristics

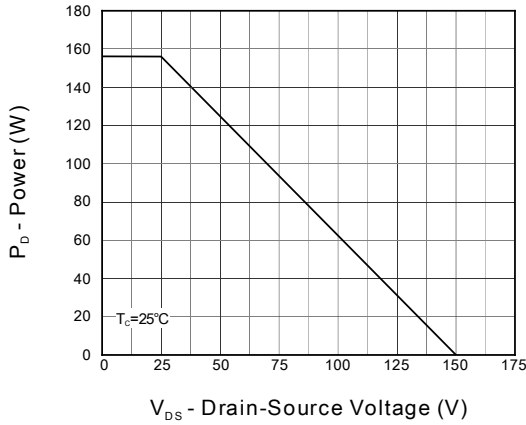

Figure 1. Output Characteristics

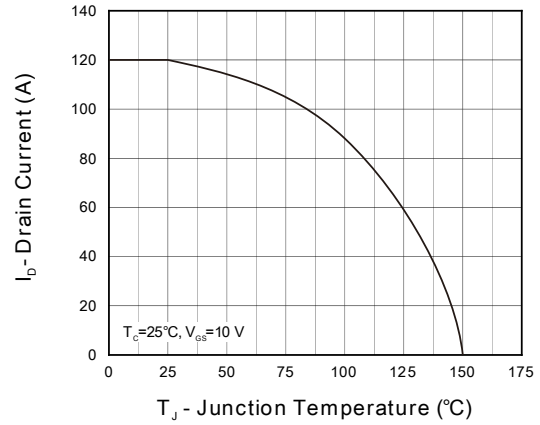

Figure 2. Current Capability

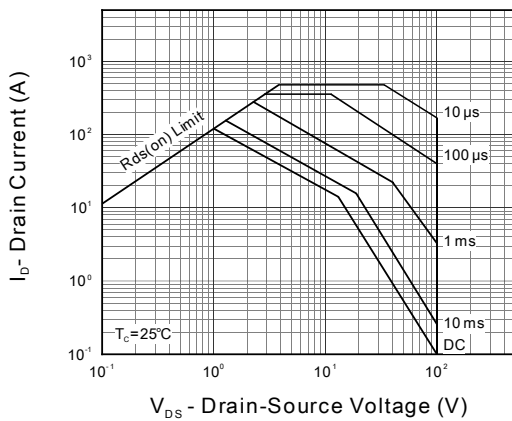

Figure 3. Safe Operation Area

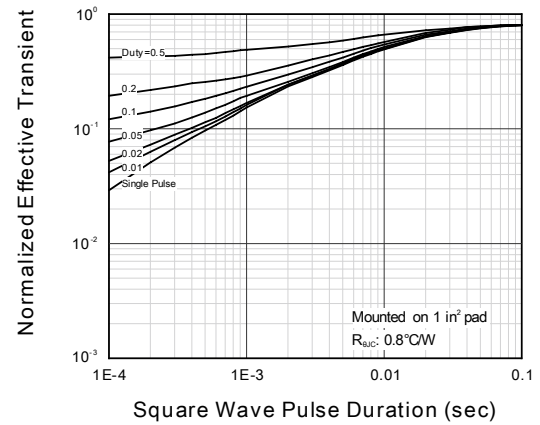

Figure 4. Transient Thermal Impedance

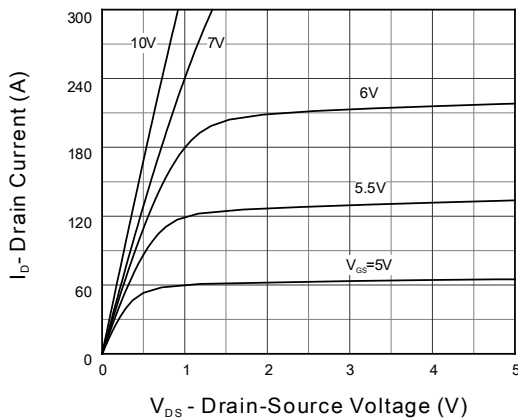

Figure 5. Output Characteristics

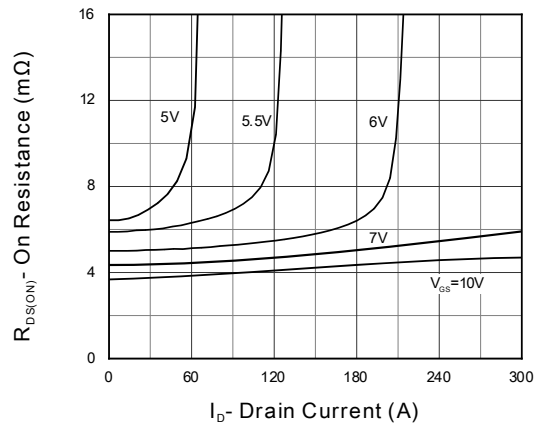

Figure 6. On Resistance

7. Typical Characteristics (cont.)

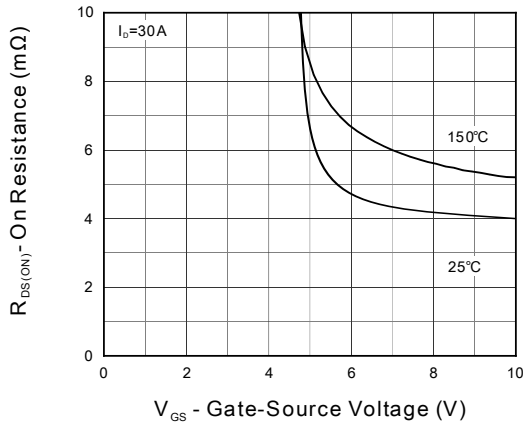

Figure 7. Transfer Characteristics

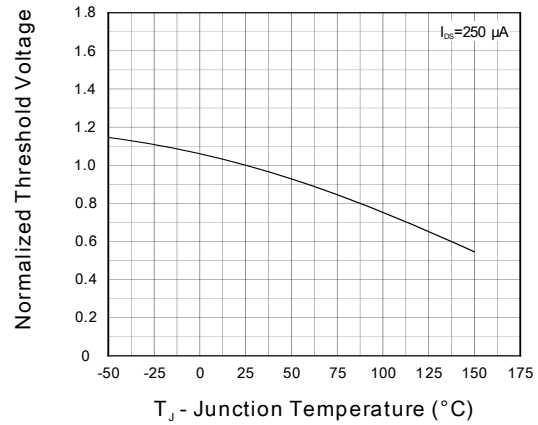

Figure 8. Normalized Threshold Voltage

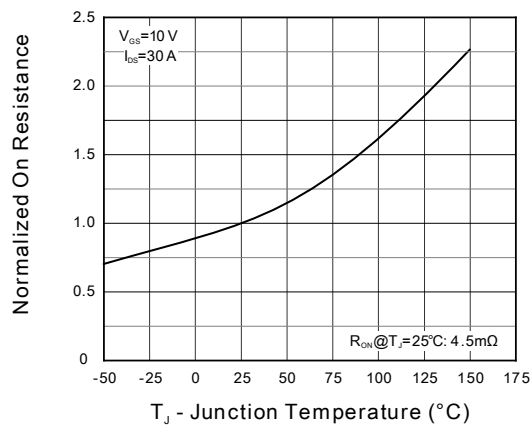

Figure 9. Normalized On Resistance

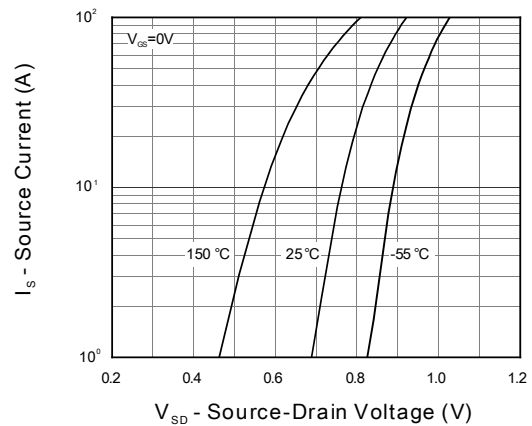

Figure 10. Diode Forward Current

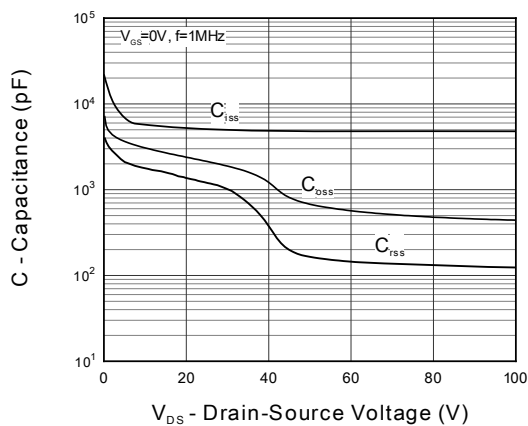

Figure 11. Capacitance

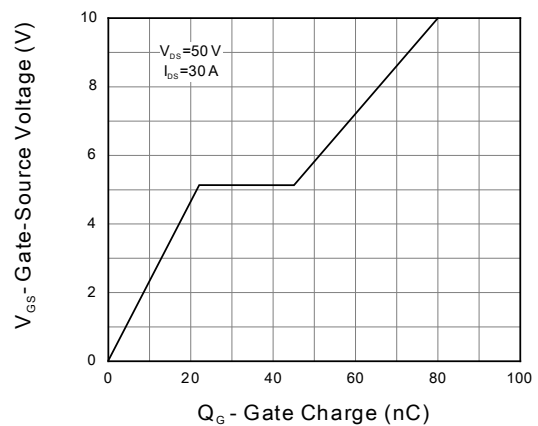
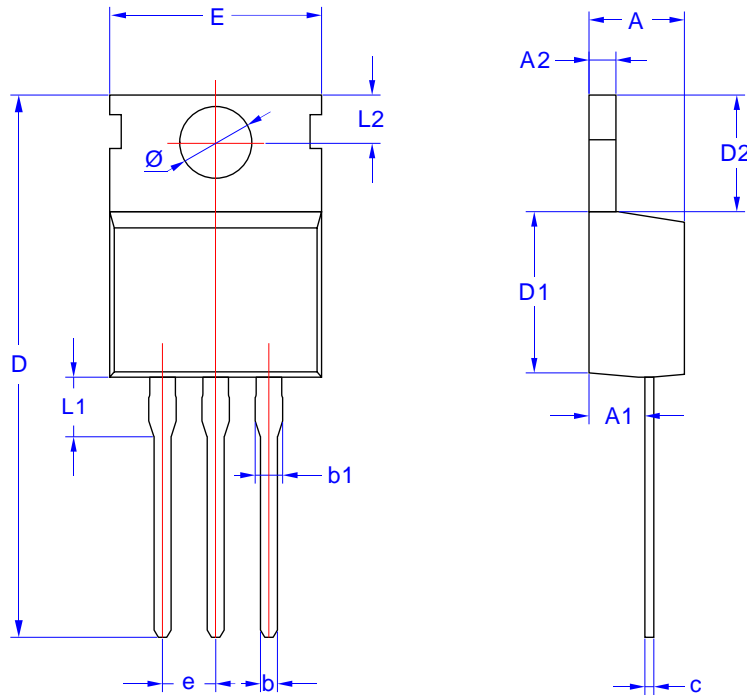

Figure 12. Gate Charge

8. Package Dimensions

TO-220 Package



Symbol	Dimensions in Millimeters	
	MIN	MAX
A	4.24	4.70
A1	2.20	3.00
A2	1.15	1.40
b	0.70	0.95
b1	1.14	1.70
c	0.40	0.60
D	28.0	29.8
D1	8.80	9.90
D2	6.25	6.90
E	9.70	10.50
L1	3.80	
L2	2.40	3.00
e	2.54 BSC	
Φ	3.60	