

N-Channel Enhancement Mode MOSFET

1. Product Information

1.1 Features

- Surface-mounted package
- Low thermal resistance
- Low Gate Charge
- 100% UIS Tested

1.2 Applications

- Motor drivers
- Automotive

1.3 Quick reference

- $BV \geq 150\text{ V}$
- $R_{DS(ON)} \leq 6\text{ m}\Omega @V_{GS} = 10\text{ V}$
- $P_D \leq 430\text{ W}$
- $I_D \leq 166\text{ A}$

2. Pin Description

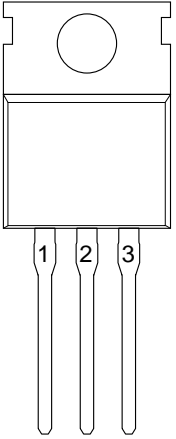
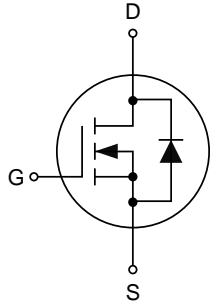
Pin	Description	Simplified Outline	Symbol
1	Gate (G)		
2	Drain (D)		
3	Source (S)		

Top View
TO-220

3. Limiting Values

Symbol	Parameter	Conditions	Min	Max	Unit
V_{DS}	Drain-Source Voltage	$T_C=25^{\circ}\text{C}$	-	150	V
V_{GS}	Gate-Source Voltage	$T_C=25^{\circ}\text{C}$	-	± 20	V
I_D^*	Drain Current (DC)	$T_C=25^{\circ}\text{C}, V_{GS}=10\text{ V}$	-	166	A
		$T_C=100^{\circ}\text{C}, V_{GS}=10\text{ V}$	-	117	A
$I_{DM}^{*,**}$	Drain Current (Pulsed)	$T_C=25^{\circ}\text{C}, V_{GS}=10\text{ V}$	-	600	A
P_D	Drain Power Dissipation	$T_C=25^{\circ}\text{C}$	-	430	W
I_S	Diode Continuous Current	$T_C=25^{\circ}\text{C}$	-	420	A
E_{AS}^*	Single Pulsed Avalanche Energy	$V_{DD}=75\text{ V}, L=0.3\text{mH}$	-	540	mJ
T_J, T_{stg}	Operating Junction and Storage Temperature Range		-55	175	$^{\circ}\text{C}$
$R_{\theta JA}^*$	Thermal Resistance-Junction to Ambient		-	46	$^{\circ}\text{C}/\text{W}$
$R_{\theta JC}$	Thermal Resistance-Junction to Case		-	0.35	

Notes:

- * Surface mounted on 1 in² pad area, $t \leq 10$ sec.
- ** Pulse width $\leq 300\ \mu\text{s}$, duty cycle $\leq 2\%$.
- *** Limited by bonding wire.

4. Marking Information

Product Name	Marking
KJ060N15C	<div style="border: 1px solid black; padding: 5px; display: inline-block;"> KJ060N15C YWWXXX </div>

5. Ordering Code

Product Name	Package	Reel size	Tape width	Quantity (pcs)
KJ060N15C	TO-220	N/A	N/A	1000

Note: KUIJIEXIN defines "Green" as lead-free (RoHS compliant) and halogen free (Br or Cl does not exceed 900 ppm by weight in homogeneous material and total of Br and Cl does not exceed 1500 ppm by weight; Follow IEC 61249-2-21 and IPC/JEDEC J-STD-020C).

6. Electrical Characteristics (T_J=25°C unless otherwise noted)

Symbol	Parameter	Conditions	Min	Typ	Max	Unit
Static Characteristics						
BV _{DSS}	Drain-Source Breakdown Voltage	V _{GS} =0 V, I _{DS} =250 μA	150	-	-	V
V _{GS(th)}	Gate Threshold Voltage	V _{DS} =V _{GS} , I _{DS} =250 μA	2.5	-	4.5	V
I _{DSS}	Drain Source Current	V _{DS} =120 V, V _{GS} =0 V	-	-	1	μA
I _{GSS}	Gate Leakage Current	V _{DS} =0 V, V _{GS} =±20 V	-	-	±100	nA
R _{DS(ON)} ^a	On-State Resistance	V _{GS} =10 V, I _{DS} =20 A	-	5	6	mΩ
g _{FS}	Forward Transconductance	V _{GS} =5 V, I _{DS} =20 A	-	65	-	S
R _g	Gate Resistance	V _{DS} =0 V, V _{GS} =0 V, f=1 MHz	-	2.1	-	Ω
Diode Characteristics						
V _{SD} ^a	Diode Forward Voltage	V _{GS} =0 V, I _{SD} =1 A	-	-	1.0	V
t _{rr}	Reverse Recovery Time	V _{GS} =0 V, I _{SD} =15 A, dI _{SD} /dt=100 A/μs	-	100	-	ns
Q _{rr}	Reverse Recovery Charge		-	150	-	nC
Dynamic Characteristics^b						
C _{iss}	Input Capacitance	V _{DS} =75 V, V _{GS} =0 V, f=1 MHz	-	4320	-	pF
C _{oss}	Output Capacitance		-	535	-	
C _{rss}	Reverse Transfer Capacitance		-	7.2	-	
t _{d(on)}	Turn-on Delay Time	V _{DS} =75 V, V _{GEN} =10 V, R _G =3.75 Ω, R _L =6 Ω, I _{DS} =15 A	-	18.5	-	ns
t _r	Turn-on Rise Time		-	30	-	
t _{d(off)}	Turn-off Delay Time		-	53	-	
t _f	Turn-off Fall Time		-	41	-	
Gate Charge Characteristics^b						
Q _g	Total Gate Charge	V _{DS} =75 V, V _{GS} =10 V, I _{DS} =20 A	-	68	-	nC
Q _{gs}	Gate-Source Charge		-	43	-	
Q _{gd}	Gate-Drain Charge		-	15	-	

Notes:

- Pulse test; pulse width ≤ 300 μs, duty cycle ≤ 2%.
- Guaranteed by design, not subject to production testing.

7. Typical Characteristics

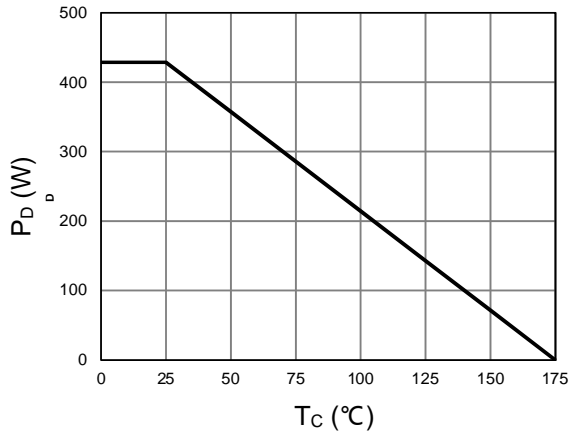

Figure 1. Power Capability

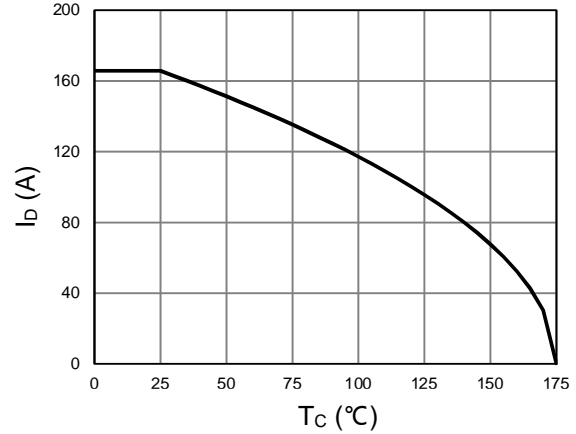

Figure 2. Current Capability

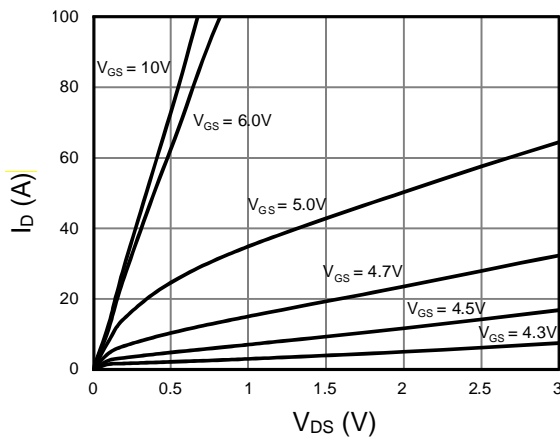

Figure 3. Output characteristics

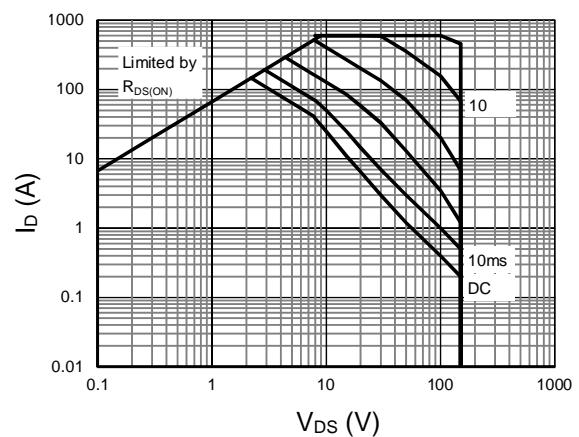

Figure 4. Safe operating area

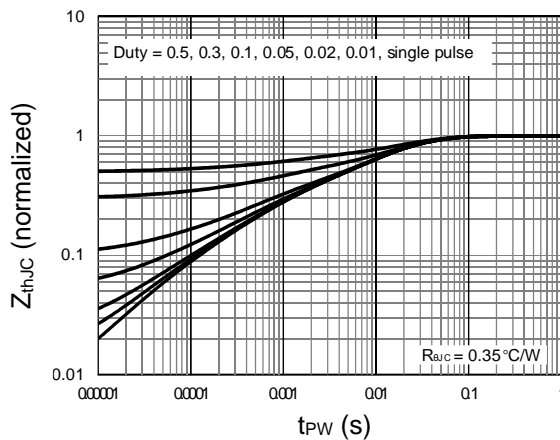

Figure 5. Normalized transient thermal impedance from junction to case

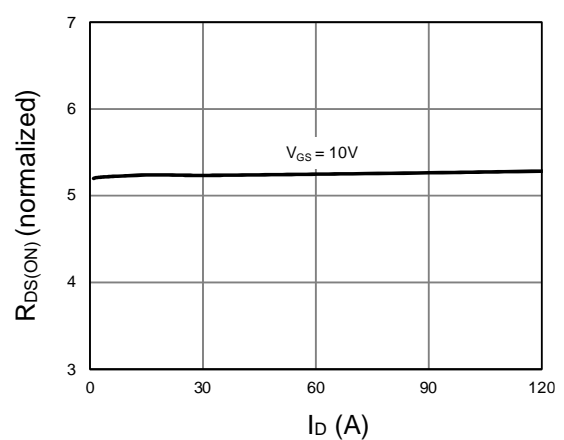

Figure 6. Normalized on-resistance vs drain current

7. Typical Characteristics (cont.)

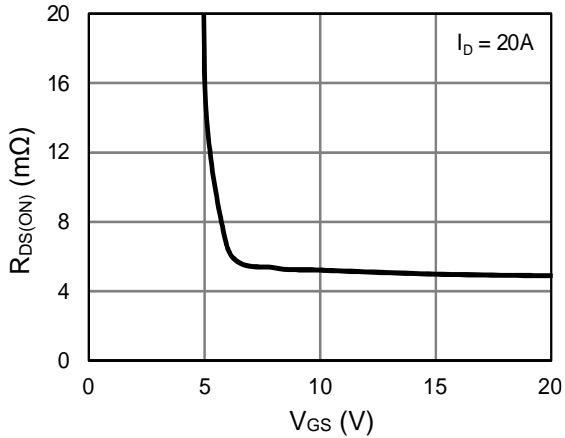

Figure 7. On-resistance vs gate-source voltage

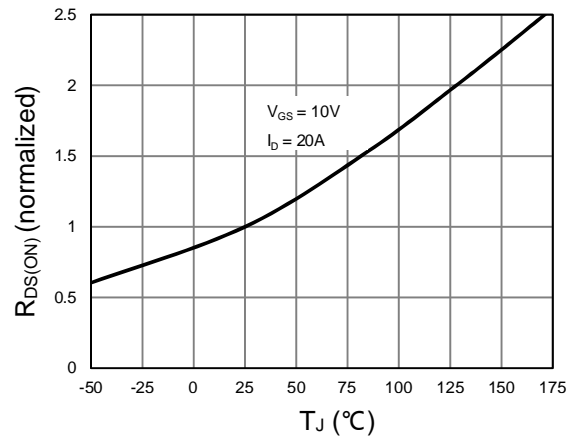

Figure 8. Normalized on-resistance vs junction temperature

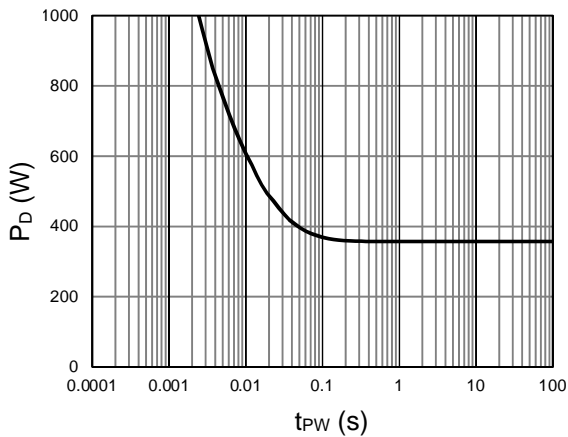

Figure 9. Single pulse maximum power dissipation

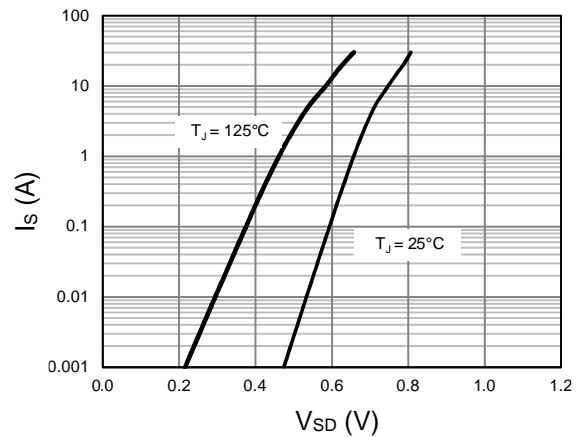

Figure 10. Forward characteristics of body diode

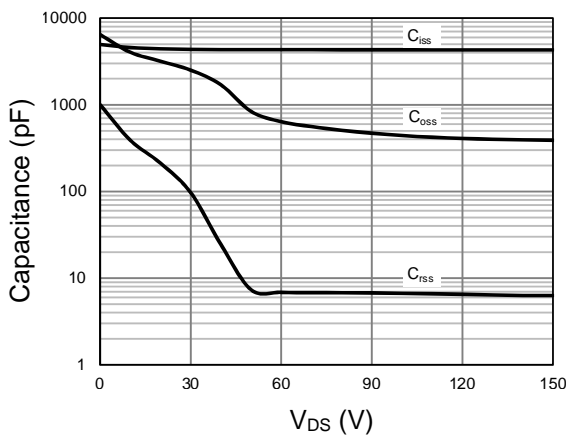

Figure 11. Capacitance

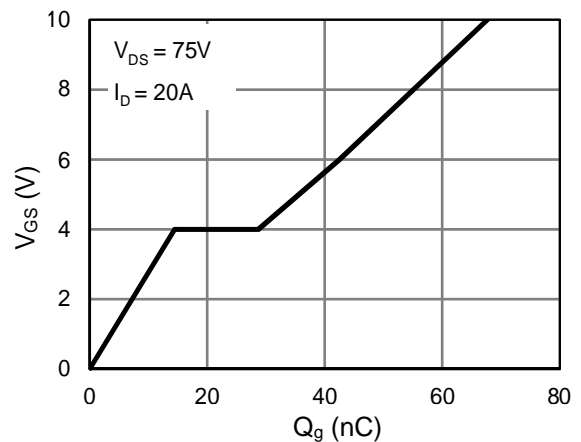
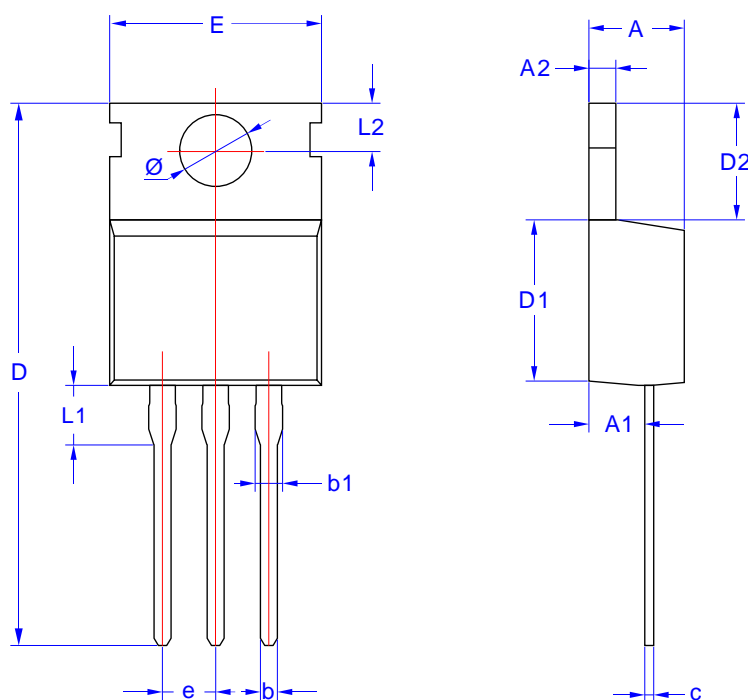

Figure 12. Gate charge

8. Package Dimensions

TO-220 Package



Symbol	Dimensions in Millimeters	
	MIN	MAX
A	4.24	4.70
A1	2.20	3.00
A2	1.15	1.40
b	0.70	0.95
b1	1.14	1.70
c	0.40	0.60
D	28.0	29.8
D1	8.80	9.90
D2	6.25	6.90
E	9.70	10.50
L1	3.80	
L2	2.40	3.00
e	2.54 BSC	
ϕ	3.60	